



M & E

**PICK HERE TO VISIT
OUR WEBSITE.**

**DESIGNER AND MANUFACTURER
OF QUALITY PARTS**

WWW.MEGROUPINC.COM

CONTENTS: (ALPHABETICAL)

ADHESIVE CEILING LOOP	PAGE 6	"J" HOOK WITH ADHESIVE	PAGE 6
ADHESIVE WIRE/PEN CLIP	PAGE 44	K-RIZE CABLE ADJUSTERS	PAGE 17
ALL PURPOSE ADHESIVE CLIP	PAGE 44	K-RIZE CABLE & ADJUSTER KITS	PAGE 17
ALUMINUM BINDER POST EXTENSIONS	PAGE 27	LOCKING STRAPS (CABLE TIES)	PAGE 23
ALUMINUM BINDER POST & SCREWS	PAGE 26	LOOPED END CABLE ASSEMBLIES	PAGE 16
ALUMINUM CEILING HOOK	PAGE 3	MAGNETIC HOOKS	PAGE 3
BARBED CORDS	PAGE 9	MANUFACTURERS' PART NUMBER	
BIT SNAP LINK	PAGE 14	CROSS REFERENCE GUIDE	PAGE 36
BLACK ALUMINUM BINDER POST & SCREWS	PAGE 27	METAL CEILING TWIST LOOP	PAGE 3
BRANCHED MULTI-CORD CEILING CLIPS	PAGE 7	METAL CEILING TWIST STUD	PAGE 2
BRASS BINDER POST & SCREWS	PAGE 28	METAL JACK CHAIN	PAGE 18
"C" CHANNEL SHELF MOLDING	PAGE 51	METAL JACK CHAIN KIT	PAGE 18
"C" LINKS	PAGE 10	METAL SQUEEZE CLIP & CORD	PAGE 8
CABLE SLEEVES (CRIMPS)	PAGE 16	PALLET DISPLAY CLIP	PAGE 44
CEILING HOOK & CORD	PAGE 7	PEAR CLIPS	PAGE 12
CEILING SWIVEL LOOP CLIP	PAGE 5	PEGBOARD/SLATWALL ADAPTERS	PAGE 42
CEILING TWIST CLIP & CORD	PAGE 6	PEGBOARD/SLATWALL POWER WING CLIP	PAGE 42
CEILING TWIST LOOP	PAGE 4	PERF SHELF CHANNEL FASTENER	PAGE 31
CEILING TWIST LOOP-HEAVY DUTY	PAGE 4	PERF SHELF DART CLIP	PAGE 31
CHANNEL MOUNT ARROW FASTENERS	PAGE 37	PERF SHELF "S" HOOKS	PAGE 12
CHANNEL MOUNT SPRING WOBBLER	PAGE 40	PERF SHELF UNIVERSAL FASTENERS	PAGE 30
CHANNEL MOUNT WITH ADHESIVE	PAGE 39	PERF SHELF WHITE SNAP RIVET	PAGE 32
CLEAR HINGED CEILING HOOK	PAGE 4	PLASTIC GRID CLIP WITH HOLE	PAGE 5
CLEAR POWER WIRE WING CLIP	PAGE 40	PLASTIC SNAP RING	PAGE 14
CLIP-ON CEILING LOOP	PAGE 5	PLASTIC SPIRAL RING	PAGE 14
CLIP-ON CORRUGATED SHELF SUPPORTS	PAGE 43	POLE SIGN LOCKING STRAP KITS	PAGE 23
COMBINATION ECONOMY WRENCH	PAGE 20	POWER WIRE WING CLIPS	PAGE 41
DART (ARROW) CLIP FASTENER	PAGE 34	PREMIUM SUCTION CUP-METAL HOOK	PAGE 24
DART CLIP - SMALL	PAGE 33	PREMIUM SUCTION CUP-MUSHROOM HEAD	PAGE 24
DIAMOND HOLE SHELF DART CLIP	PAGE 31	PREMIUM SUCTION CUP-PILOT HOLE	PAGE 24
DIAMOND HOLE SHELF PUSH-IN CLIP	PAGE 32	PRICE CHANNEL SIGN HOLDER	PAGE 39
DOUBLE "C" HOOKS	PAGE 11	QUICK-GRIP WASHER FASTENER	PAGE 30
DOUBLE END X-MAS TREE FASTENER	PAGE 34	RATCHET RIVET FASTENER	PAGE 29
EASY-FLEX CHANNEL MOUNT ARROW FASTENER	PAGE 37	RING HANDLES	PAGE 13
ECONOMY SCREWDRIVERS	PAGE 20	ROTATABLE GRIPPER SIGN HOLDER	PAGE 45
ELASTIC BARBED CORDS	PAGE 10	"S" HOOKS	PAGE 11
EXPAND-A-LOCK CONNECTOR	PAGE 32	SCREW LOCK RINGS	PAGE 13
FFR-DSI PART NO. CROSS-REFERENCE GUIDE	PAGES 53-55	SECONDARY OPERATIONS / DIRECT	
FIGURE "8" SQUEEZE CLIP	PAGE 1	OVERSEAS MILL IMPORT SERVICES	PAGE 57
FIVE CAVITY HEAVY DUTY SWAGER	PAGE 19	SELF ADHESIVE INFO STRIPS	PAGE 51
FLIP-UP COVERED FACE SIGN HOLDER	PAGE 51	SELF-PIERCING CHANNEL FLAG HOLDER	PAGE 38
FLIP-UP PALLET TAG	PAGE 52	SELF-PIERCING CHANNEL FLUSH HOLDER	PAGE 38
GONDOLA TOP GRIPPER SIGN HOLDER	PAGE 49	SELF-PIERCING FLAG SIGN HOLDER	PAGE 38
GRID CEILING SPANNER BAR	PAGE 1	SHELF SUPPORT CLIPS	PAGE 43
GRIPPER 90 DEGREE TWO-WAY PANEL FORMER	PAGE 50	SINGLE CAVITY HAND SWAGER	PAGE 19
GRIPPER 180 DEGREE "H" PANEL FORMER	PAGE 50	SINGLE END ECONOMY WRENCHES	PAGE 20
GRIPPER FLUSH SIGN HOLDER	PAGE 46	SLATWALL ADAPTER WITH ADHESIVE	PAGE 42
GRIPPER "H" SIGN HOLDER	PAGE 47	SNAP RIVET FASTENER	PAGE 29
GRIPPER SIGN HOLDER	PAGE 47	SPRING WOBBLER	PAGE 40
GRIPPER SIGN HOLDER-EXTRA WIDE BASE	PAGE 48	STANDARD STEEL FASTENER PRODUCTS	PAGES 56 & 57
GRIPPER SQUARE EDGE SIGN HOLDER	PAGE 49	STEEL BARREL BOLT EXTENSION	PAGE 29
GRIPPER T-STYLE TABLE TOP SIGN HOLDER	PAGE 49	STEEL BARREL BOLTS & SCREWS	PAGE 28
GRIPPER TWIST-IN SIGN HOLDER	PAGE 39	STEEL CABLE	PAGE 15
GRIPPER "U" CHANNEL PANEL FORMER	PAGE 50	STEEL CABLE (WIRE ROPE) CUTTER	PAGE 18
GRIPPER WIRE FLAG SIGN HOLDER	PAGE 46	SQUEEZE CLIP	PAGE 1
GRIPPER WIRE FLUSH SIGN HOLDER	PAGE 46	THREE CAVITY HAND SWAGER	PAGE 19
"H" CHANNEL WITH ADHESIVE	PAGE 52	TIP-ON FLUSH SIGN HOLDER	PAGE 45
HANGING COIL	PAGE 2	TRIWAY MOBILE KIT	PAGE 8
HEAVY DUTY EXPAND-A-LOCK	PAGE 33	"U" HOOK	PAGE 12
HEAVY DUTY GRIPPER SIGN HOLDER-NARROW	PAGE 48	UPRIGHT FLIP INSERTS	PAGE 21
HEAVY DUTY GRIPPER SIGN HOLDER-WIDE	PAGE 48	"V" CLIP	PAGE 2
HEAVY DUTY POWER WIRE WING CLIP	PAGE 41	VIKING CLIP FASTENER - PUSH ON TYPE	PAGE 30
HEAVY DUTY SQUEEZE CLIP	PAGE 2	WALL ANCHOR - HEAVY DUTY	
HINGED GRIPPER SIGN HOLDERS	PAGE 47	TOGGLE WING	PAGE 22
HINGED SNAP RINGS	PAGE 13	WALL ANCHOR - LIGHT DUTY CONICAL	PAGE 21
HOOK & LOOP FASTENERS	PAGE 25	WALL ANCHOR - MEDIUM DUTY ZIP-IT®	PAGE 22
"J" CHANNEL WITH ADHESIVE	PAGE 52	X-MAS TREE CLIP FASTENER	PAGE 35
"J" HOOK WIRE SIGN HOLDER	PAGE 45	Z-BAR SLATWALL ADAPTER	PAGE 43

GRID CEILING SPANNER BAR

24" OVERALL LENGTH x 1" WIDE WITH NOTCHED ENDS - .048 THICK ALUMINUM, PAINTED WHITE. COMPATIBLE WITH MOST GRID CEILINGS. WORKS IN CONJUNCTION WITH ALL TYPES OF METAL AND PLASTIC CEILING CLIPS AND HOOKS (SOLD SEPARATELY).

PACKAGING: BULK.

NOTES: SPANNER BARS ALLOW FOR PINPOINT POSITIONING OF SIGNAGE AT ANY LOCATION ON THE CEILING WITHOUT BEING LIMITED TO THE LOCATION OF EXISTING CEILING GRIDS. NO TOOLS REQUIRED. SIMPLY ROTATE ENDS IN PLACE OVER EXISTING CEILING GRID EDGES - NOTCHED ENDS ALLOW FOR A SECURE OVERLAP. ALSO KNOWN AS CROSS BEAMS AND TILE DIVIDERS.

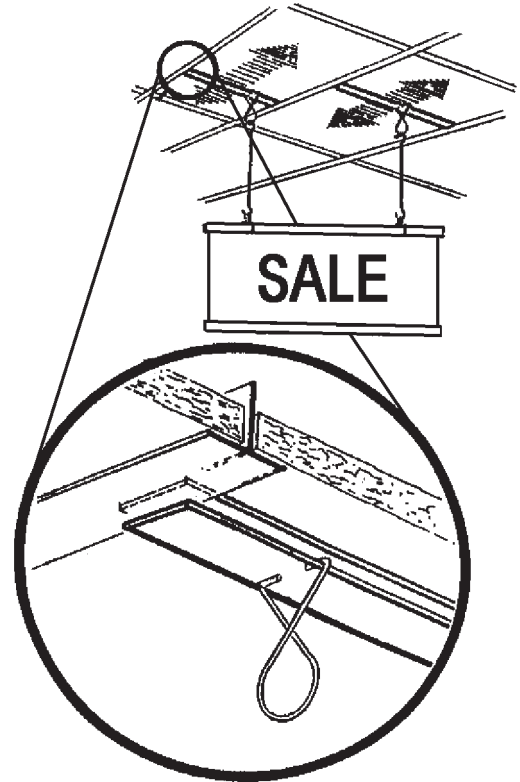

<u>PART #</u>	<u>CTN QTY</u>	<u>DESCRIPTION</u>	<u>WT PER/M</u>
104100	150	24" OVERALL LENGTH	248 Lbs

FIGURE "8" SQUEEZE CLIP

.062 WIRE DIAMETER, SPRING STEEL, BRIGHT GALVANIZED WITH 2-1/2" OVERALL LENGTH.

PACKAGING: BAGGED 100 PER.

NOTES: LOCKS SECURELY ON CEILING GRID WITH A SQUEEZE.

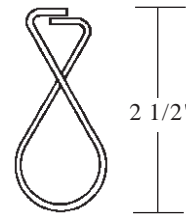

<u>PART #</u>	<u>CTN QTY</u>	<u>DESCRIPTION</u>	<u>WT PER/M</u>
107004	5,000	.062 WIRE DIA X 2-1/2" LONG	5.6 Lbs

SQUEEZE CLIP

.062 WIRE DIAMETER, SPRING STEEL, BRIGHT GALVANIZED WITH 3" OVERALL LENGTH.

PACKAGING: BAGGED 100 PER.

NOTES: OUR MOST POPULAR CEILING GRID CLIP. LOCKS ON TO CEILING GRID WITH A SIMPLE SQUEEZE.



<u>PART #</u>	<u>CTN QTY</u>	<u>DESCRIPTION</u>	<u>WT PER/M</u>
107003	5,000	.062 WIRE DIA X 3" LONG	7.9 Lbs

HEAVY DUTY SQUEEZE CLIP

.072 WIRE DIAMETER, SPRING STEEL, BRIGHT GALVANIZED WITH 2-1/2" OVERALL LENGTH.

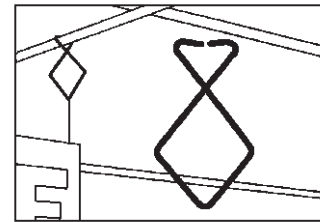

PACKAGING: BAGGED 100 PER.

NOTES: 90 DEGREE BENDS COUPLED WITH LARGER WIRE DIAMETER MAKES THIS CEILING CLIP STRONGER THAN OTHER COMMON SQUEEZE STYLES.

<u>PART #</u>	<u>CTN QTY</u>	<u>DESCRIPTION</u>	<u>WT PER/M</u>
107002	5,000	.072 WIRE DIA X 2-1/2" LONG	8.2 Lbs

"V" CLIP

.047 WIRE DIAMETER, SPRING STEEL, GALVANIZED WITH 1" LEG LENGTH.

PACKAGING: BAGGED 500 PER.

NOTES: MOST ECONOMICAL WAY TO ATTACH TO A GRID CEILING. VERY STRONG FOR ITS SMALL SIZE.



<u>PART #</u>	<u>CTN QTY</u>	<u>DESCRIPTION</u>	<u>WT PER/M</u>
107001	10,000	.047 WIRE DIA X 1" LONG	1.4 Lbs

HANGING COIL

.040 WIRE DIAMETER, SPRING STEEL, GALVANIZED WITH 3/8" O.D. X 1-1/4" LONG.

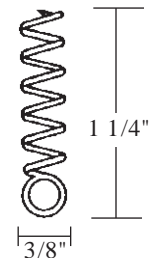

PACKAGING: BAGGED 100 PER.

NOTES: SCREWS INTO ANY LOCATION ON AN ACOUSTIC TILE CEILING. ALSO USE ON FOAM BOARD EDGES. SMALL LOOP MAKES IT GREAT FOR USE WITH BARBED CORDS.

<u>PART #</u>	<u>CTN QTY</u>	<u>DESCRIPTION</u>	<u>WT PER/M</u>
106001	5,000	3/8" O.D. X 1-1/4" LONG	2.0 Lbs

METAL CEILING TWIST STUD

1" WIDE x 1-1/2" LONG, 20 GAUGE SPRING STEEL PAINTED WHITE WITH 1/4-20 x 5/8" LONG FULLY THREADED STUD-STEEL-ZINC PLATED. FOR USE ON STANDARD 15/16" CEILING GRID TEE BARS.

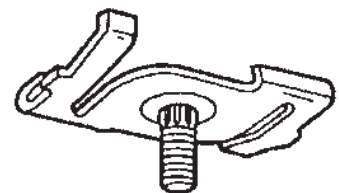

PACKAGING: BULK.

NOTES: SUPERIOR GRIP. SUPER STRONG SPRING STEEL. TWIST ON TO LOCK SECURELY ON CEILING GRID. STUD ALLOWS FOR ATTACHMENT TO A VARIETY OF SIGNS AND FIXTURES. NO SPECIAL TOOLS REQUIRED. LONGER STUD LENGTHS ALSO AVAILABLE.

<u>PART #</u>	<u>CTN QTY</u>	<u>DESCRIPTION</u>	<u>WT PER/M</u>
107022	1,000	1/4-20 X 5/8" STUD-WHITE	26.8 Lbs

METAL CEILING TWIST LOOP

1" WIDE x 1 1/2" LONG WITH 15/64" LOOP I.D., 20 GAUGE SPRING STEEL PAINTED WHITE. FOR USE ON STANDARD 15/16" CEILING GRID TEE BARS.

PACKAGING: BULK.

NOTES: SUPERIOR GRIP. SUPER STRONG SPRING STEEL. TWIST ON TO LOCK SECURELY ON CEILING GRID. WHEN LOCKED IN PLACE, THIS IS OUR STRONGEST CEILING CLIP. NO SPECIAL TOOLS REQUIRED.

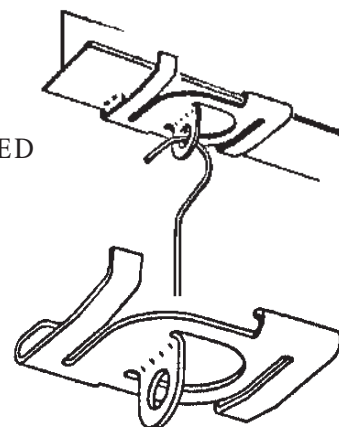

<u>PART #</u>	<u>CTN QTY</u>	<u>DESCRIPTION</u>	<u>WT PER/M</u>
107021	1,000	15/64" LOOP I.D.-WHITE	15.2 Lbs

MAGNETIC HOOKS

ROUND MAGNET BASE WITH ROUND METAL HOUSING WITH HOOK ATTACHMENT. ALL THREE SIZES OFFERED ARE 1-1/4" OVERALL LENGTH. BOTH 1" AND 1-1/4" DIA. ARE POWDER COATED WHITE, 2" DIA. IS CHROME PLATED.

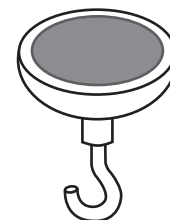

PACKAGING: BULK.

NOTES: DISPLAY LIGHTWEIGHT SIGNS AND PRODUCTS FROM METAL SURFACES. MAGNETS ARE EASILY PLACED AND REMOVED. ATTACHES WELL TO MOST FERROUS METAL SURFACES. OPEN HOOK END CAN BE PINCHED CLOSED TO FORM AN EYE (PLEASE INQUIRE).

WARNING: HOLDING CAPACITY IS THE APPROXIMATE MAXIMUM PULL RATING UNDER IDEAL CONDITIONS. ALWAYS TEST SUITABILITY ON A PER APPLICATION BASIS. FOR BEST RESULTS, USE ON AN INDOOR, BARE (UNFINISHED) METAL SURFACE THAT IS SMOOTH AND CLEAN. METAL CONDITIONS WILL AFFECT HOLDING POWER.

<u>PART #</u>	<u>CTN QTY</u>	<u>O.D.</u>	<u>VERTICAL CAPACITY</u>	<u>HORIZONTAL CAPACITY</u>	<u>HOOK OPENING</u>	<u>WT PER/M</u>
107030	500	1"	5 Lbs	9 Lbs	.187	61.0 Lbs
107031	400	1-1/4"	8 Lbs	14 Lbs	.187	89.5 Lbs
107032	100	2"	12 Lbs	20 Lbs	.312	154.0 Lbs

ALUMINUM CEILING HOOK

1" WIDE X 1-1/2" LONG WITH 1/4" HOOK OPENING (ASSEMBLED SIZE) CEILING GRID TRACK HOOK - .040 THICK ALUMINUM, PAINTED WHITE. COMPLETE ASSEMBLY REQUIRES TWO PIECES (A LEFT AND RIGHT) - WHICH ARE SOLD SEPARATELY.

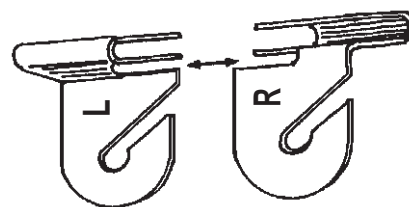

PACKAGING: BULK.

NOTES: INTERLOCKING TWO PIECE METAL HOOK IS REUSABLE AND EXTREMELY STURDY. EASY "SLIDE ON" CEILING GRID INSTALLATION. SIMPLY SLIDE ONE INTERLOCKING LEFT AND RIGHT TOGETHER TO FORM A HOOK (AS SHOWN) OR TWO LEFTS / TWO RIGHTS TO FORM A RING.

<u>PART #</u>	<u>CTN QTY</u>	<u>DESCRIPTION</u>	<u>WT PER/M</u>
107026	2,000	WHITE ALUMINUM HOOK -LEFT	7.5 Lbs
107027	2,000	WHITE ALUMINUM HOOK -RIGHT	7.5 Lbs

CLEAR HINGED CEILING HOOK

3/4" WIDE X 1-3/8" LONG WITH 21/64" HOOK OPENING HINGED STYLE CEILING GRID TRACK HOOK - TRANSPARENT LEXAN.

PACKAGING: BAGGED 100 PER.

NOTES: ONE PIECE CLEAR PLASTIC HOOK HINGES OPEN AND CLOSES AROUND CEILING GRID. EASY ON / EASY OFF. CLEAR COLOR IS UNNOTICEABLE.

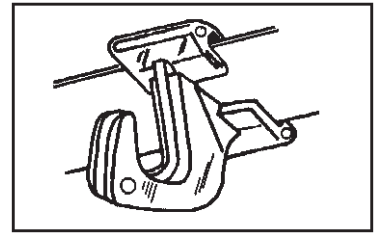

<u>PART #</u>	<u>CTN QTY</u>	<u>DESCRIPTION</u>	<u>WT PER/M</u>
107025	600	CLEAR HINGED HOOK	12.5 Lbs

CEILING TWIST LOOP

7/8" DIA. LOOP WITH 2" O.D. ROUND BASE, STYRENE MATERIAL.

PACKAGING: BULK.

NOTES: SECURELY ATTACH TO CEILING GRID WITH A SIMPLE TURN AND LOCK FEATURE. WORKS WITH MOST STANDARD EXTENSION POLES FOR EASY INSTALLATION. CAN SERVE AS A PERMANENT FIXTURE OR EASILY BE REMOVED FOR REPOSITIONING.

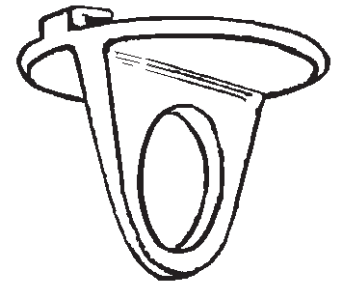

<u>PART #</u>	<u>CTN QTY</u>	<u>DESCRIPTION</u>	<u>WT PER/M</u>
107010	1,000	ROUND BASE -WHITE	25.3 Lbs
107011	1,000	ROUND BASE -IVORY (BEIGE)	25.3 Lbs

CEILING TWIST LOOP - HEAVY DUTY

7/8" DIA. LOOP WITH 2" LENGTH X 1-1/4" WIDTH RECTANGULAR BASE, STYRENE MATERIAL.

PACKAGING: BULK.

NOTES: SECURELY ATTACH TO CEILING GRID WITH A SIMPLE TURN AND LOCK FEATURE. WORKS WITH MOST STANDARD EXTENSION POLES FOR EASY INSTALLATION. CAN SERVE AS A PERMANENT FIXTURE OR EASILY BE REMOVED FOR REPOSITIONING.

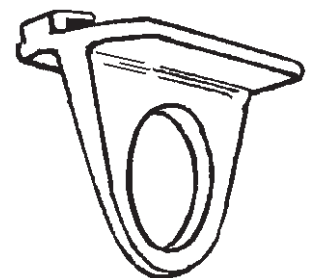

<u>PART #</u>	<u>CTN QTY</u>	<u>DESCRIPTION</u>	<u>WT PER/M</u>
107015	1,000	RECTANGULAR BASE-WHITE	21.8 Lbs
107016	1,000	RECTANGULAR BASE-IVORY (BEIGE)	21.8 Lbs

PLASTIC GRID CLIP WITH HOLE

5/32" DIA. HOLE WITH 3/4" LENGTH X 5/8" WIDTH. MATERIAL: WHITE IS POLYPROPYLENE AND CLEAR IS TRANSLUCENT POLYPROPYLENE.

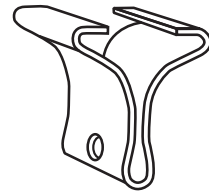

PACKAGING: BAGGED 250 PER.

NOTES: PLASTIC CLIP GRABS CEILING GRID FOR TIGHT AND SECURE ATTACHMENT. AN ALTERNATIVE TO WIRE CLIPS AND SAFER THAN OPEN HOOKS. SMALL HOLE MAKES IT GREAT FOR USE WITH BARBED CORDS.

<u>PART #</u>	<u>CTN QTY</u>	<u>DESCRIPTION</u>	<u>WT PER/M</u>
107019	10,000	3/4" LONG - CLEAR	2.9 Lbs
107020	10,000	3/4" LONG - WHITE	2.9 Lbs

CLIP-ON CEILING LOOP

3/4" X 3/4" BASE WITH 1/2" LEG LENGTH AND 3/16" DIA. LOOP. OVERALL HEIGHT IS .469. WHITE POLYPROPYLENE MATERIAL.

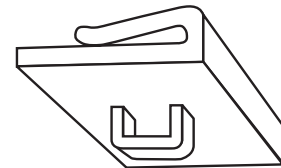

PACKAGING: BAGGED 250 PER.

NOTES: ALSO KNOWN AS A "MINI-CLIPPER", THIS CLIP CONNECTS SECURELY TO ONE SIDE OF CEILING GRID. ALSO FITS WELL ON THE LIP OF PERIMETER CEILING GRID FOR HANGING SIGNS AND BANNERS FLUSH TO THE WALL. SMALL HOLE (LOOP) MAKES IT GREAT FOR ATTACHING BARBED CORDS, HOOKS AND LOCKING RINGS.

<u>PART #</u>	<u>CTN QTY</u>	<u>DESCRIPTION</u>	<u>WT PER/M</u>
107024	10,000	3/4" SQUARE-WHITE	2.7 Lbs

CEILING SWIVEL LOOP CLIP

1" LONG X 3/4" WIDE WITH .156 LOOP I.D. SNAPS ONTO STANDARD 15/16" CEILING GRID TEE BARS. LOOP ROTATES UP TO 360 DEGREES FOR PINPOINT POSITIONING OF SIGNAGE. WHITE STYRENE MATERIAL.

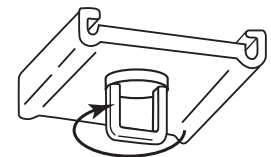

PACKAGING: BAGGED 250 PCS PER.

NOTES: ROTATE A SIGN TO JUST THE RIGHT VIEWING ANGLE WITH A SIMPLE ROTATION OF THE LOOP. PLASTIC CLIP GRABS THE CEILING GRID FOR A SECURE ATTACHMENT. SMALL LOOP SIZE IS GREAT FOR USE WITH WIRE HOOKS AND BARBED CORDS.

<u>PART #</u>	<u>CTN QTY</u>	<u>DESCRIPTION</u>	<u>WT PER/M</u>
107029	10,000	3/4" WIDE BASE-WHITE	2.3 Lbs

ADHESIVE CEILING LOOP

3/4" X 3/4" BASE WITH ADHESIVE BACKING AND 3/16" DIA. LOOP.
OVERALL HEIGHT IS .328. WHITE POLYPROPYLENE MATERIAL.

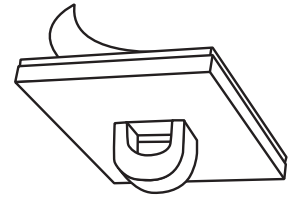

PACKAGING: BAGGED 250 PER.

NOTES: SIMPLY PEEL AND STICK FOR A SECURE HOLD ON CEILING GRIDS OR ANY OTHER CLEAN/FLAT SURFACE. SMALL HOLE (LOOP) MAKES IT GREAT FOR ATTACHING BARBED CORDS, TAGS AND LIGHTWEIGHT HOOKS.

<u>PART #</u>	<u>CTN QTY</u>	<u>DESCRIPTION</u>	<u>WT PER/M</u>
107023	10,000	3/4" SQUARE BASE-WHITE	1.5 Lbs

"J" HOOK WITH ADHESIVE

1" X 1" BASE WITH ADHESIVE BACKING AND 11/32" HOOK OPENING.
OVERALL HEIGHT IS 7/8". WHITE STYRENE MATERIAL.

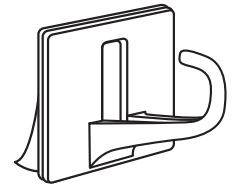

PACKAGING: 8 PIECES PER SHEET.

NOTES: HANG HORIZONTALLY OR VERTICALLY. SIMPLY PEEL AND STICK FOR A SECURE HOLD ON CEILING GRIDS OR ANY OTHER CLEAN/FLAT SURFACE. HOOK OPENING MAKES IT GREAT FOR ATTACHING LIGHTWEIGHT RINGS AND HOOKS.

<u>PART #</u>	<u>CTN QTY</u>	<u>DESCRIPTION</u>	<u>WT PER/M</u>
107028	2,800	1" SQUARE BASE-WHITE	3.8 Lbs

CEILING TWIST CLIP & CORD

2" CLIP LENGTH X 1/2" WIDTH. POLYPROPYLENE MATERIAL - WHITE WITH BRAIDED POLYESTER WHITE OR CLEAR MONOFILAMENT BARBED CORD WOUND ON CLIP.

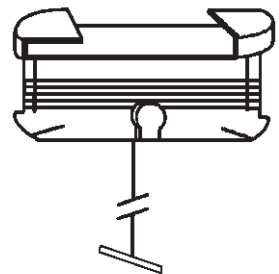

PACKAGING: BAGGED 100 PER.

NOTES: PLASTIC CLIP ATTACHES TO CEILING GRID WITH A SIMPLE TURN AND LOCK FEATURE. UNWIND WOUND BARBED CORD TO DESIRED LENGTH. USE TO SUSPEND LIGHTWEIGHT SIGNS, MOBILES AND BANNERS. WORKS WITH MOST STANDARD EXTENSION POLES FOR EASY INSTALLATION.

<u>PART #</u>	<u>CTN QTY</u>	<u>DESCRIPTION</u>	<u>WT PER/M</u>
107034	4,000	4 FT BARBED CORD-WHITE	8.1 Lbs
107034C	4,000	4 FT BARBED CORD-CLEAR	8.1 Lbs
107036	4,000	6 FT BARBED CORD-WHITE	8.5 Lbs
107036C	4,000	6 FT BARBED CORD-CLEAR	8.5 Lbs
107038	4,000	8 FT BARBED CORD-WHITE	8.9 Lbs
107038C	4,000	8 FT BARBED CORD-CLEAR	8.9 Lbs

CEILING HOOK & CORD

2-1/4" HOOK LENGTH. POLYPROPYLENE MATERIAL - WHITE WITH BRAIDED POLYESTER WHITE, BLACK OR CLEAR MONOFILAMENT BARBED CORD WOUND ON CLIP.

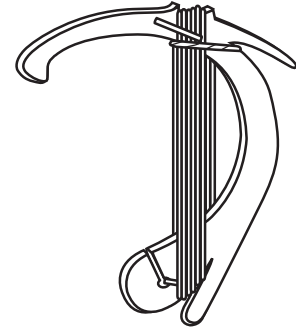

PACKAGING: BAGGED 100 PER.

NOTES: VERSATILE PLASTIC HOOK INSTALLS EASILY ON A VARIETY OF EXPOSED CEILING SUPPORTS OR GRIDS. UNWIND WOUND BARBED CORD TO DESIRED LENGTH. USE TO SUSPEND LIGHTWEIGHT SIGNS, MOBILES AND BANNERS. WORKS WITH MOST STANDARD EXTENSION POLES FOR EASY INSTALLATION.

<u>PART #</u>	<u>CTN QTY</u>	<u>DESCRIPTION</u>	<u>WT PER/M</u>
107044	4,000	4 FT BARBED CORD-WHITE	9.7 Lbs
107044B	4,000	4 FT BARBED CORD-BLACK	9.7 Lbs
107044C	4,000	4 FT BARBED CORD-CLEAR	9.7 Lbs
107046	4,000	6 FT BARBED CORD-WHITE	10.1 Lbs
107046B	4,000	6 FT BARBED CORD-BLACK	10.1 Lbs
107046C	4,000	6 FT BARBED CORD-CLEAR	10.1 Lbs

BRANCHED MULTI-CORD CEILING CLIPS

TWO CEILING GRID ATTACHMENT STYLES AVAILABLE: OUR STANDARD TWIST CLIP (2" WIDTH) AND HOOK (2-1/4" LENGTH). BOTH ARE MADE OF WHITE POLYPROPYLENE MATERIAL WITH 6 FT. WHITE BRAIDED POLYESTER CORD (4 FT CORD PLUS 2 FT BARBED BRANCHES) WOUND ON CLIP.

PACKAGING: BAGGED 100 PER.

NOTES: TWIST-ON STYLE CLIP ATTACHES TO CEILING GRID WITH A SIMPLE TURN AND LOCK FEATURE. VERSATILE HOOK INSTALLS EASILY ON A VARIETY OF EXPOSED CEILING SUPPORTS AND GRIDS. USE TO SUSPEND THREE OR FOUR PANEL LIGHTWEIGHT SIGNS OR MOBILES. UNWIND WOUND BARBED CORD TO DESIRED LENGTH. WORKS WITH MOST STANDARD EXTENSION POLES FOR EASY INSTALLATION.

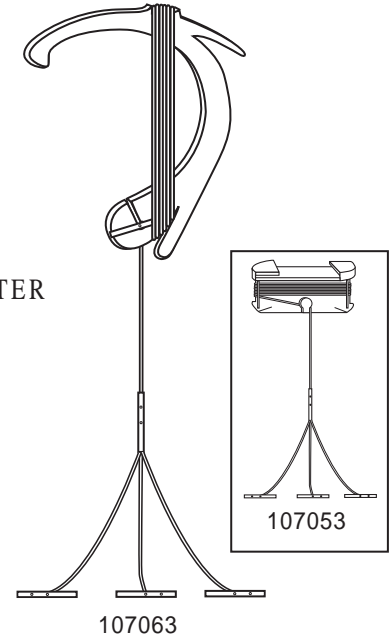

<u>PART #</u>	<u>CTN QTY</u>	<u>STYLE</u>	<u>DESCRIPTION</u>	<u>WT PER/M</u>
107053	4,000	TWIST-ON	6 FT LONG, 3 BRANCHES	9.1 Lbs
107054	4,000	TWIST-ON	6 FT LONG, 4 BRANCHES	9.3 Lbs
107063	4,000	HOOK	6 FT LONG, 3 BRANCHES	11.0 Lbs
107064	4,000	HOOK	6 FT LONG, 4 BRANCHES	11.2 Lbs

METAL SQUEEZE CLIP & CORD

.062 WIRE DIA., SPRING STEEL, BRIGHT GALVANIZED X 3-1/2" O.A.L. WITH BRAIDED POLYESTER WHITE OR BLACK BARBED CORD WOUND ON CLIP.

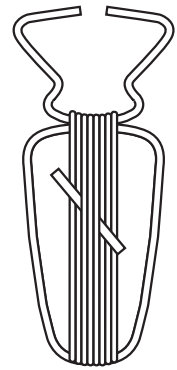

PACKAGING: BAGGED 100 PER.

NOTES: LOCKS ONTO CEILING GRID WITH A SIMPLE SQUEEZE. UNWIND BARBED CORD TO DESIRED LENGTH. USE TO SUSPEND LIGHTWEIGHT SIGNS, MOBILES AND BANNERS.

<u>PART #</u>	<u>CTN QTY</u>	<u>DESCRIPTION</u>	<u>WT PER/M</u>
107056	2,000	6 FT. BARBED CORD-WHITE	11.5 Lbs
107056B	2,000	6 FT. BARBED CORD-BLACK	11.5 Lbs

TRIWAY MOBILE KIT

SMALL: 6-3/8" WIDE X 5/16" THICK, THREE SIDED.
LARGE: 12-5/8" WIDE X 1/2" THICK, THREE SIDED.
POLYPROPYLENE MATERIAL - NATURAL.

PACKAGING: SINGLE POLYBAGGED KIT.

NOTES: SINGLE POLYBAGGED KIT CONTAINS A 6 FT WHITE CEILING HOOK & CORD, TWO TRIANGULAR FORMERS AND ASSEMBLY INSTRUCTIONS. PLASTIC FORMERS SUPPORT AND HANG GRAPHIC POSTERS. ALSO CAN ACCOMODATE DISPLAY POLES (1"-1-1/2" O.D.) AND TURNING MOTORS BY SIMPLY REMOVING THE CENTER DISK IN THE BOTTOM FORMER. AN INEXPENSIVE WAY TO TURN ADVERTISING POSTERS INTO EYE CATCHING, THREE SIDED, MOBILE OR POLE TOPPED DISPLAYS. EASY ASSEMBLY.

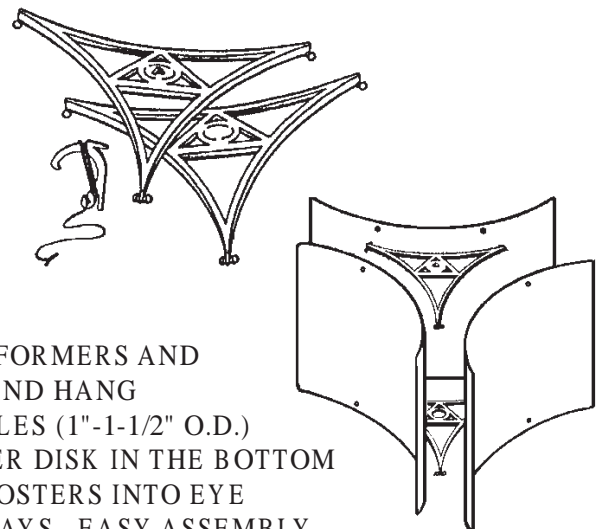

POSTER HOLE INFO - HOLE SIZES SHOULD BE 7/32" DIA. TO ACCOMMODATE FORMER POP THRU TIPS. 4 HOLES ARE REQUIRED PER POSTER. ALL POSTERS MUST BE THE SAME SIZE FOR PROPER BALANCE.

SMALL TRIWAY - TOP AND BOTTOM PLASTIC FORMERS SECURE 3 POSTERS FROM 10"-24" WIDE. THE TOP AND BOTTOM PAIR OF HOLES SHOULD BE 3-3/16" TO EACH SIDE OF THE CENTER OF THE POSTER.

LARGE TRIWAY - TOP AND BOTTOM PLASTIC FORMERS SECURE 3 POSTERS FROM 20"-40" WIDE. THE TOP AND BOTTOM PAIR OF HOLES SHOULD BE 6-5/16" TO EACH SIDE OF THE CENTER OF THE POSTER.

<u>PART #</u>	<u>CTN QTY</u>	<u>DESCRIPTION</u>	<u>WT PER/M</u>
107060	400	SMALL (FOR 10"-24" POSTERS)	99.0 Lbs
107061	140	LARGE (FOR 20"-40" POSTERS)	219.0 Lbs

BARBED CORDS

MADE OF DURABLE BRAIDED 10/5 POLYESTER CORD - WHITE AND BLACK (TANGLE RESISTANT) OR .020 DIA. CLEAR MONOFILAMENT CORD ALL WITH .094 DIA X 5/8" LONG STEEL - ZINC BARB ON BOTH ENDS. LENGTH OF BARBED CORD IS MEASURED BETWEEN THE BARBS.

PACKAGING: BUNDLED 100 PER.

NOTES: USE IN CONJUNCTION WITH A PLASTIC GRID CLIP OR HANGING COIL TO ECONOMICALLY SUSPEND LIGHTWEIGHT SIGNS. RECOMMENDED PANEL HOLE SIZE IS 1/8" - 3/16" DIA. CLEAR MONO CORD APPEARS NEARLY INVISIBLE. OTHER LENGTHS AND CUSTOM ENDS ALSO AVAILABLE.

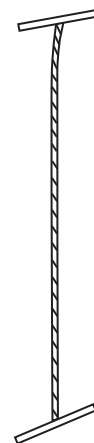

<u>PART #</u>	<u>CTN QTY</u>	<u>DESCRIPTION</u>	<u>WT PER/M</u>
109001	10,000	1" LONG CORD -WHITE	0.5 L bs
109001B	10,000	1" LONG CORD -BLACK	0.5 L bs
109001C	10,000	1" LONG CORD -CLEAR	0.5 L bs
109002	10,000	2" LONG CORD -WHITE	0.5 L bs
109002B	10,000	2" LONG CORD -BLACK	0.5 L bs
109002C	10,000	2" LONG CORD -CLEAR	0.5 L bs
109003	10,000	3" LONG CORD -WHITE	0.5 L bs
109003B	10,000	3" LONG CORD -BLACK	0.5 L bs
109003C	10,000	3" LONG CORD -CLEAR	0.5 L bs
109004	10,000	4" LONG CORD -WHITE	0.5 L bs
109004B	10,000	4" LONG CORD -BLACK	0.5 L bs
109004C	10,000	4" LONG CORD -CLEAR	0.5 L bs
109006	10,000	6" LONG CORD -WHITE	0.6 L bs
109006B	10,000	6" LONG CORD -BLACK	0.6 L bs
109006C	10,000	6" LONG CORD -CLEAR	0.6 L bs
109008	10,000	8" LONG CORD -WHITE	0.6 L bs
109008B	10,000	8" LONG CORD -BLACK	0.6 L bs
109008C	10,000	8" LONG CORD -CLEAR	0.6 L bs
109010	10,000	10" LONG CORD -WHITE	0.7 L bs
109010B	10,000	10" LONG CORD -BLACK	0.7 L bs
109010C	10,000	10" LONG CORD -CLEAR	0.7 L bs
109012	10,000	12" LONG CORD -WHITE	0.7 L bs
109012B	10,000	12" LONG CORD -BLACK	0.7 L bs
109012C	10,000	12" LONG CORD -CLEAR	0.7 L bs
109018	10,000	18" LONG CORD -WHITE	0.8 L bs
109018B	10,000	18" LONG CORD -BLACK	0.8 L bs
109018C	10,000	18" LONG CORD -CLEAR	0.8 L bs

ELASTIC BARBED CORDS

ELASTIC RUBBER INNER CORD WRAPPED IN DURABLE .060 DIA. WHITE OR BLACK POLYESTER WITH .109 DIA. X 11/16" LONG STEEL-ZINC BARB ON BOTH ENDS. LENGTH OF BARBED CORD IS MEASURED BETWEEN THE BARBS.

PACKAGING: BUNDLED 100 PER.

NOTES: STRETCHES TO APPROXIMATELY TWICE ITS LENGTH. USE TO HOLD AND SUSPEND LIGHTWEIGHT SIGNS. RECOMMENDED PANEL HOLE SIZE IS 1/8" - 3/16" DIA. OTHER LENGTHS, CUSTOM ENDS AND COLORS ALSO AVAILABLE.



<u>PART #</u>	<u>CTN QTY</u>	<u>DESCRIPTION</u>	<u>WT PER M</u>
109051	10,000	1" LONG ELASTIC CORD-WHITE	0.8 L bs
109051B	10,000	1" LONG ELASTIC CORD-BLACK	0.8 L bs
109052	10,000	2" LONG ELASTIC CORD-WHITE	0.9 L bs
109052B	10,000	2" LONG ELASTIC CORD-BLACK	0.9 L bs
109053	10,000	3" LONG ELASTIC CORD-WHITE	1.0 L bs
109053B	10,000	3" LONG ELASTIC CORD-BLACK	1.0 L bs
109054	10,000	4" LONG ELASTIC CORD-WHITE	1.1 L bs
109054B	10,000	4" LONG ELASTIC CORD-BLACK	1.1 L bs
109056	10,000	6" LONG ELASTIC CORD-WHITE	1.2 L bs
109056B	10,000	6" LONG ELASTIC CORD-BLACK	1.2 L bs
109058	10,000	8" LONG ELASTIC CORD-WHITE	1.4 L bs
109058B	10,000	8" LONG ELASTIC CORD-BLACK	1.4 L bs
109060	10,000	10" LONG ELASTIC CORD-WHITE	1.6 L bs
109060B	10,000	10" LONG ELASTIC CORD-BLACK	1.6 L bs
109062	10,000	12" LONG ELASTIC CORD-WHITE	1.8 L bs
109062B	10,000	12" LONG ELASTIC CORD-BLACK	1.8 L bs
109068	10,000	18" LONG ELASTIC CORD-WHITE	2.3 L bs
109068B	10,000	18" LONG ELASTIC CORD-BLACK	2.3 L bs

"C" LINKS

.093 WIRE DIAMETER, STEEL, BRIGHT GALVANIZED.

PACKAGING: BAGGED 100 PER.

NOTES: ECONOMICAL WAY TO HANG MULTIPLE SIGNS EVENLY AND STRAIGHT ONE BELOW THE OTHER.

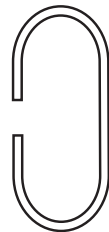

<u>PART #</u>	<u>CTN QTY</u>	<u>DESCRIPTION</u>	<u>WT PER M</u>
108001	5,000	1-1/2" OVERALL LENGTH (15/32" OPENING)	5.5 L bs
108002	5,000	3" OVERALL LENGTH (5/8" OPENING)	12.5 L bs

DOUBLE "C" HOOKS

.093 WIRE DIAMETER, STEEL, BRIGHT GALVANIZED WITH 5/8" HOOK OPENING.

PACKAGING: BUNDLED 50 PER.

NOTES: ECONOMICAL FIXED LENGTH HOOKS HANG SIGNS LEVEL. ALSO KNOWN AS "HANGWIRES".

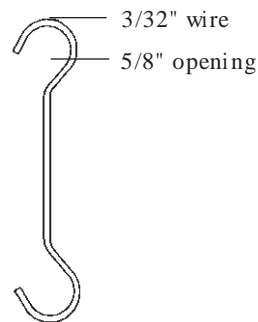

<u>PART #</u>	<u>CTN QTY</u>	<u>DESCRIPTION</u>	<u>WT PER/M</u>
108010	2,500	4" OVERALL LENGTH	11.1 L bs
108011	2,300	6" OVERALL LENGTH	15.0 L bs
108012	2,200	8" OVERALL LENGTH	18.8 L bs
108013	2,000	10" OVERALL LENGTH	22.2 L bs
108014	1,800	12" OVERALL LENGTH	26.7 L bs
108015	1,300	16" OVERALL LENGTH	33.5 L bs
108016	1,300	18" OVERALL LENGTH	37.8 L bs
108017	1,000	20" OVERALL LENGTH	41.4 L bs
108018	1,000	24" OVERALL LENGTH	49.7 L bs
108019	800	28" OVERALL LENGTH	57.8 L bs
108020	800	30" OVERALL LENGTH	60.6 L bs
108021	400	36" OVERALL LENGTH	70.0 L bs
108022	400	40" OVERALL LENGTH	79.6 L bs
108023	400	48" OVERALL LENGTH	95.7 L bs

"S" HOOKS

STEEL, BRIGHT GALVANIZED.

PACKAGING: BULK.

NOTES: NICE RANGE OF COMMON LENGTHS AND DIAMETERS FOR VARIOUS HANGING APPLICATIONS.



<u>PART #</u>	<u>CTN QTY</u>	<u>DESCRIPTION</u>	<u>WT PER/M</u>
108003	10,000	.080 WIRE DIA X 1" LONG	3.2 L bs
108004	10,000	.093 WIRE DIA X 7/8" LONG	3.5 L bs
108005	5,000	.120 WIRE DIA X 1-5/16" LONG	9.4 L bs
108006	5,000	.135 WIRE DIA X 1-5/8" LONG	14.2 L bs
108007	2,000	.148 WIRE DIA X 2" LONG	22.7 L bs
108008	1,000	.177 WIRE DIA X 2-7/8" LONG	39.6 L bs

PERF SHELF "S" HOOKS

.080 WIRE DIAMETER X 1-3/4" LONG STEEL BRIGHT GALVANIZED.

PACKAGING: BAGGED 500 PER.

NOTES: THESE EXTRA LARGE "S" HOOKS ARE SPECIALLY DESIGNED FOR HANGING MERCHANDISING STRIPS FROM PERFORATED SHELVING. VERY ECONOMICAL AND VERSATILE. THE "PINCHED" STYLE PREVENTS HOOK FROM FALLING OFF OF PRE-ASSEMBLED STRIPS DURING SHIPMENT.

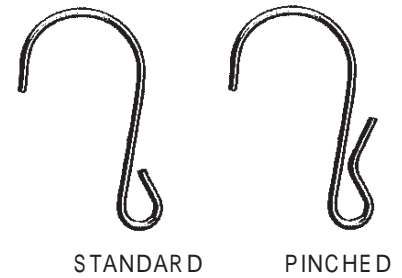

<u>PART #</u>	<u>CTN QTY</u>	<u>DESCRIPTION</u>	<u>WT PER/M</u>
108009	5,000	.080 DIA X 1-3/4" LONG-STANDARD	4.4 L bs
108029	5,000	.080 DIA X 1-3/4" LONG-PINCHED	5.0 L bs

"U" HOOK

.093 WIRE DIAMETER, STEEL, BRIGHT GALVANIZED WITH 1/4" I.D. LOOPED ENDS X 2" OVERALL LENGTH X 3/4" WIDE. FOR USE WITH SIGN MATERIAL UP TO 3/4" THICK.

PACKAGING: BAGGED 100 PER.

NOTES: IN CONJUNCTION WITH BINDER POST AND SCREWS (UP TO 3/4" LONG), "U" HOOKS ARE POPULAR FOR USE ON FOAM BOARD AND OTHER THICK SIGN MATERIAL. ALSO USE TO ATTACH TWO SIGN PANELS BACK TO BACK. POST AND SCREW SOLD SEPARATELY (SEE PAGE 26).

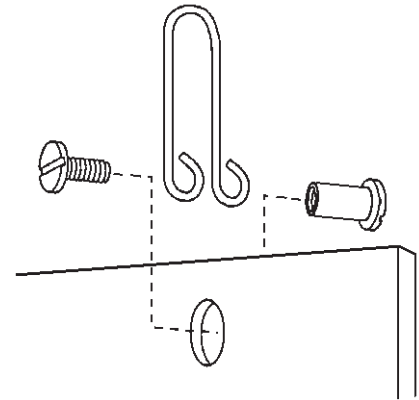

<u>PART #</u>	<u>CTN QTY</u>	<u>DESCRIPTION</u>	<u>WT PER/M</u>
106002	5,000	.093 WIRE DIA X 2" LONG	7.2 L bs

PEAR CLIPS

.080 WIRE DIAMETER, SPRING STEEL, WITH 2-1/2" LENGTH AND 1-3/8" DIA. INSIDE LOOP. (STAINLESS STEEL IS .090 WIRE DIAMETER).

PACKAGING: BULK.

NOTES: STRONG CONSTRUCTION. CLIPS TOTALLY SHUT FOR SECURE CLOSURE. ALSO KNOWN AS A SHOWER CURTAIN RING OR GOLF TOWEL CLIP.



<u>PART #</u>	<u>CTN QTY</u>	<u>DESCRIPTION</u>	<u>WT PER/M</u>
101001	5,000	SPRING STEEL - ZINC PLATED	10.8 L bs
101008	5,000	SPRING STEEL - BRASS PLATED	10.8 L bs
101009	5,000	STAINLESS STEEL	12.8 L bs

HINGED SNAP RINGS

STEEL, NICKEL PLATED MULTI-PURPOSE RING.

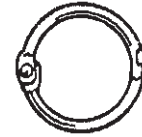

PACKAGING: BAGGED AS SHOWN BELOW.

NOTES: HINGED DESIGN SNAPS EASILY AND LOCKS SECURELY. ALSO KNOWN AS LOOSELEAF RING (BOOK RING) OR HINGED KEY RING. **WARNING:** SMALL SIZES MAY BE DIFFICULT TO OPEN.

<u>PART #</u>	<u>CTN QTY</u>	<u>BAG QTY</u>	<u>DESCRIPTION</u>	<u>WT PER/M</u>
101015	10,000	200	1/2" I.D., .079 WIRE DIAMETER	3.3 L bs
101002	7,000	200	3/4" I.D., .091 WIRE DIAMETER	5.5 L bs
101003	3,000	200	1" I.D., .109 WIRE DIAMETER	9.4 L bs
101016	3,000	100	1-1/4" I.D., .109 WIRE DIAMETER	12.1 L bs
101004	3,000	100	1-1/2" I.D., .118 WIRE DIAMETER	15.7 L bs
101005	1,500	50	2" I.D., .118 WIRE DIAMETER	20.4 L bs
101006	750	50	2-1/2" I.D., .130 WIRE DIAMETER	28.2 L bs
101007	500	10	3" I.D., .170 WIRE DIAMETER	64.1 L bs

SCREW LOCK RINGS

STRONG, MULTI-PURPOSE OVERSIZED RINGS. STEEL, NICKEL PLATED.

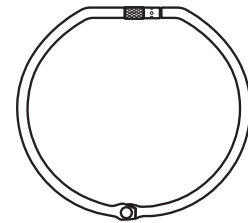

PACKAGING: BULK.

NOTES: WELL SUITED FOR BULKY LOOSELEAF MATERIAL, SWATCHES OR SAMPLES. HINGED DESIGN AND THREADED LOCKING DEVICE HOLD SECURELY.

<u>PART #</u>	<u>CTN QTY</u>	<u>DESCRIPTION</u>	<u>WT PER/M</u>
101052	1,000	2" I.D., .156 WIRE DIAMETER	40.0 L bs
101053	500	3" I.D., .203 WIRE DIAMETER	100.0 L bs
101054	350	4" I.D., .203 WIRE DIAMETER	115.0 L bs
101055	250	5" I.D., .203 WIRE DIAMETER	170.0 L bs
101056	250	6" I.D., .203 WIRE DIAMETER	210.0 L bs
101057	200	7" I.D., .218 WIRE DIAMETER	240.0 L bs
101058	200	8" I.D., .218 WIRE DIAMETER	270.0 L bs
101060	100	10" I.D., .218 WIRE DIAMETER	345.0 L bs

RING HANDLES

THREE POPULAR LENGTHS TO CHOOSE FROM ALL MADE FROM .250" DIAMETER STEEL WITH DURABLE NICKEL PLATING. MEASURE LENGTH OF HANDLE FROM INSIDE OF LOOP TO INSIDE OF LOOP.



PACKAGING: BULK.

NOTES: USE IN CONJUNCTION WITH METAL HINGED SNAP RINGS OR SCREW LOCK RINGS TO HOLD BULKY LOOSELEAF MATERIAL, SAMPLES OR SWATCHES. 1/4" DIA. WIRE IS VERY STRONG.

<u>PART #</u>	<u>CTN QTY</u>	<u>DESCRIPTION</u>	<u>WT PER/M</u>
101037	250	7 INCH LENGTH	163 L bs
101039	150	9 INCH LENGTH	190 L bs
101040	150	10 INCH LENGTH	203 L bs

BIT SNAP LINK

.192 WIRE DIAMETER WITH 7/32" SNAP OPENING. STEEL, ZINC PLATED.

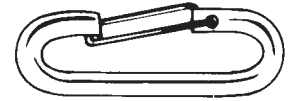

PACKAGING: BULK.

NOTES: OVAL SHAPED, SPRING SNAP CLOSED DESIGN CONNECTOR THAT OFFERS MULTIPLE USES. SECURELY LINK OR HANG MOST ANYTHING LIGHT DUTY. **WARNING:** NOT DESIGNED FOR LIFTING.

<u>PART #</u>	<u>CTN QTY</u>	<u>DESCRIPTION</u>	<u>WT PER/M</u>
101075	1,500	1-3/4" OVERALL LENGTH	31.3 Lbs

PLASTIC SNAP RING

5/8" OPEN I.D. THAT PRESSES CLOSED TO FORM A ROUND 9/16" I.D. X 7/8" O.D. RING. MATERIAL: WHITE AND BLACK ARE POLYETHYLENE AND CLEAR IS POLYCARBONATE.

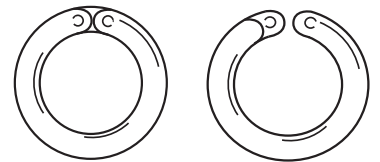

PACKAGING: BULK.

NOTES: ECONOMICAL MULTI-USE CONNECTOR LINK. EASY TO USE ONE PIECE SNAP CLOSURE DESIGN. SIMPLY PRESS CLOSED FOR HANGING OF SIGNS FROM WIRE FIXTURES OR TO MAKE LIGHT WEIGHT SAMPLE SWATCHES.

<u>PART #</u>	<u>CTN QTY</u>	<u>DESCRIPTION</u>	<u>WT PER/M</u>
101025	10,000	5/8" OPEN I.D., .156 DIAMETER-WHITE	0.9 Lbs
101025B	10,000	5/8" OPEN I.D., .156 DIAMETER-BLACK	0.9 Lbs
101025C	10,000	5/8" OPEN I.D., .156 DIAMETER-CLEAR	0.9 Lbs

PLASTIC SPIRAL RING

11/16" I.D. X 13/16" O.D. X .094 DIA. ROUND OVERLAP STYLE RING. BOTH WHITE AND CLEAR ARE RIGID PVC MATERIAL.

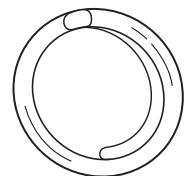

PACKAGING: BAGGED 250 PCS PER.

NOTES: COILED STYLE ECONOMICAL MULTI-USE CONNECTOR LINK. OVERLAP SPIRAL DESIGN IS EASY TO USE AND OFFERS MEMORY CLOSURE. GREAT FOR HANGING SIGNS FROM WIRE FIXTURES OR TO CREATE LIGHTWEIGHT SAMPLE SWATCHES AND FLIP CHARTS.

<u>PART #</u>	<u>CTN QTY</u>	<u>DESCRIPTION</u>	<u>WT PER/M</u>
101026	10,000	11/16" I.D.-WHITE	1.1 Lbs
101026C	10,000	11/16" I.D.-CLEAR	1.1 Lbs

STEEL CABLE

FLEXIBLE GALVANIZED AIRCRAFT QUALITY CABLE (WIRE ROPE) BARE OR CLEAR VINYL/NYLON COATED ON PLASTIC SPOOLS.

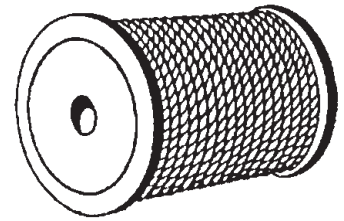

PACKAGING: SINGLE PLASTIC SPOOLS.

NOTES: CABLE IS STRONGER AND LESS EXPENSIVE THAN CHAIN. ALSO, CABLE IS THINNER AND LESS NOTICEABLE THAN CHAIN. RECOMMENDED SAFE WORKING LOAD IS A 5 TO 1 RATIO (I.E. APPROXIMATE BREAK STRENGTH DIVIDED BY 5). NYLON COATED 1/32" CABLE IS STAINLESS STEEL.

<u>PART #</u>	<u>BREAK STRENGTH</u>	<u>CTN QTY</u>	<u>DESCRIPTION</u>	<u>WT PER EA</u>
103001	110 Lbs	1 Roll	1/32" DIA (3x7) X 100' LONG, BARE	0.2 Lbs
103002	110 Lbs	1 Roll	1/32" DIA (3x7) X 250' LONG, BARE	0.5 Lbs
103003	110 Lbs	1 Roll	1/32" DIA (3x7) X 500' LONG, BARE	1.0 Lbs
103004	110 Lbs	1 Roll	1/32" DIA (3x7) X 1,000' LONG, BARE	1.9 Lbs
103013	110 Lbs	1 Roll	1/32" DIA (3x7) X 10,000' LONG, BARE	21.1 Lbs
103023	90 Lbs	1 Roll	1/32" DIA (7x7) X 100' LONG, NYLON	0.2 Lbs
103024	90 Lbs	1 Roll	1/32" DIA (7x7) X 250' LONG, NYLON	0.5 Lbs
103025	90 Lbs	1 Roll	1/32" DIA (7x7) X 500' LONG, NYLON	1.0 Lbs
103026	90 Lbs	1 Roll	1/32" DIA (7x7) X 1,000' LONG, NYLON	1.9 Lbs
103029	90 Lbs	1 Roll	1/32" DIA (7x7) X 10,000' LONG, NYLON	21.1 Lbs
103005	480 Lbs	1 Roll	1/16" DIA (7x7) X 100' LONG, BARE	0.8 Lbs
103006	480 Lbs	1 Roll	1/16" DIA (7x7) X 250' LONG, BARE	1.9 Lbs
103007	480 Lbs	1 Roll	1/16" DIA (7x7) X 500' LONG, BARE	3.9 Lbs
103008	480 Lbs	1 Roll	1/16" DIA (7x7) X 1,000' LONG, BARE	7.9 Lbs
103014	480 Lbs	1 Roll	1/16" DIA (7x7) X 5,000' LONG, BARE	43.7 Lbs
103009	270 Lbs	1 Roll	1/16" DIA (7x7) X 100' LONG, VINYL	0.6 Lbs
103010	270 Lbs	1 Roll	1/16" DIA (7x7) X 250' LONG, VINYL	1.4 Lbs
103011	270 Lbs	1 Roll	1/16" DIA (7x7) X 500' LONG, VINYL	2.8 Lbs
103012	270 Lbs	1 Roll	1/16" DIA (7x7) X 1,000' LONG, VINYL	5.4 Lbs
103015	270 Lbs	1 Roll	1/16" DIA (7x7) X 5,000' LONG, VINYL	30.9 Lbs
103031	920 Lbs	1 Roll	3/32" DIA (7x7) X 100' LONG, BARE	1.6 Lbs
103032	920 Lbs	1 Roll	3/32" DIA (7x7) X 250' LONG, BARE	4.1 Lbs
103033	920 Lbs	1 Roll	3/32" DIA (7x7) X 500' LONG, BARE	8.2 Lbs
103034	920 Lbs	1 Roll	3/32" DIA (7x7) X 1,000' LONG, BARE	16.5 Lbs
103037	920 Lbs	1 Roll	3/32" DIA (7x7) X 5,000' LONG, BARE	86.9 Lbs
103017	1,700 Lbs	1 Roll	1/8" DIA (7x7) X 100' LONG, BARE	2.9 Lbs
103018	1,700 Lbs	1 Roll	1/8" DIA (7x7) X 250' LONG, BARE	7.2 Lbs
103019	1,700 Lbs	1 Roll	1/8" DIA (7x7) X 500' LONG, BARE	14.5 Lbs
103022	1,700 Lbs	1 Roll	1/8" DIA (7x7) X 5,000' LONG, BARE	140.0 Lbs

CABLE SLEEVES (CRIMPS)

OVAL DUPLEX DESIGN FOR USE ON 1/32", 1/16", 3/32" & 1/8" DIAMETER STEEL CABLE.



PACKAGING: BULK.

NOTES: CABLE SLEEVES ARE USED IN CONJUNCTION WITH STEEL CABLE FOR LOOPING AND SWAGING ENDS. **WARNING:** SWAGING OVER VINYL OR NYLON COATED CABLE WILL RESULT IN SEVERELY REDUCED HOLDING POWER AND IS NOT RECOMMENDED IN APPLICATIONS WHERE HUMAN SAFETY, LIFTING OR FULL WIRE STRENGTH IS INVOLVED.

<u>PART #</u>	<u>CTN QTY</u>	<u>DESCRIPTION</u>	<u>WT PER/M</u>
105001	10,000	1/32" DIA COPPER/ZINC PLATED	0.5 Lbs
105002	10,000	1/16" DIA ALUMINUM	0.9 Lbs
105006	5,000	3/32" DIA ALUMINUM	3.3 Lbs
105003	2,500	1/8" DIA ALUMINUM	6.4 Lbs

LOOPED END CABLE ASSEMBLIES

1/32" DIA (1/2" LOOP LENGTH) & 1/16" DIA (3/4" LOOP LENGTH) FLEXIBLE BARE STEEL CABLE WITH FACTORY INSTALLED CRIMP-ON SLEEVES -BOTH ENDS.

PACKAGING: BULK.

NOTES: FLEXIBLE STEEL CABLE ASSEMBLIES WITH LOOPS ON ONE END (BY REQUEST) OR BOTH ENDS (STANDARD) ARE VERY STRONG AND DURABLE. CUSTOM LENGTHS, CABLE DIAMETERS, AND/OR LOOP CONFIGURATIONS ARE ALSO AVAILABLE.

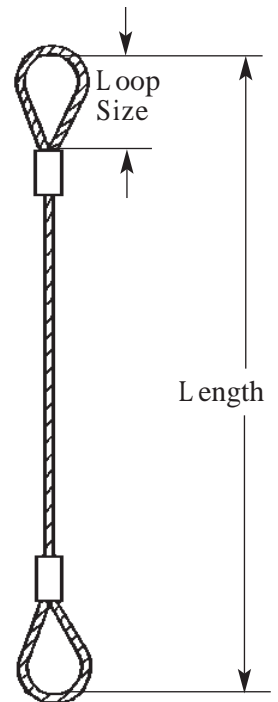

<u>PART #</u>	<u>CTN QTY</u>	<u>DESCRIPTION</u>	<u>WT PER/M</u>
102001	1,000	1/32" DIA X 6" LONG	2.0 Lbs
102002	1,000	1/32" DIA X 12" LONG	3.0 Lbs
102003	1,000	1/32" DIA X 18" LONG	4.5 Lbs
102004	1,000	1/32" DIA X 24" LONG	5.0 Lbs
102005	1,000	1/32" DIA X 36" LONG	6.5 Lbs
102012	1,000	1/32" DIA X 48" LONG	8.0 Lbs
102006	1,000	1/16" DIA X 6" LONG	7.5 Lbs
102007	1,000	1/16" DIA X 12" LONG	10.5 Lbs
102008	1,000	1/16" DIA X 18" LONG	15.5 Lbs
102009	1,000	1/16" DIA X 24" LONG	18.5 Lbs
102010	1,000	1/16" DIA X 36" LONG	25.5 Lbs
102011	1,000	1/16" DIA X 48" LONG	33.0 Lbs

OTHER CABLE END FITTINGS AVAILABLE:

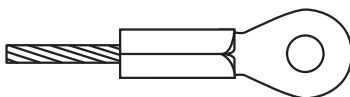

EYELET

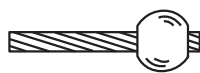

BALL

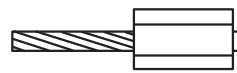

STOP SLEEVE

K-RIZE CABLE ADJUSTERS

A FAST AND EASY WAY TO FORM LOOPS WITH CABLE (SOLD SEPARATELY) TO SUSPEND SIGNS AND FIXTURES VERTICALLY OR AT SLIGHT ANGLES. ZINC ALLOY HOUSING WITH WEDGES AND SPRINGS THAT INCORPORATE A RELEASE PIN FOR EASY HEIGHT ADJUSTMENT. 1/32" SIZE IS 3/4" LONG X 7/16" WIDE, 1/16" SIZE IS 1" LONG X 1/2" WIDE AND 1/8" SIZE IS 1-1/2" LONG X 21/32" WIDE. RELIABLE BUILT-IN 5 TO 1 SAFETY FACTOR.

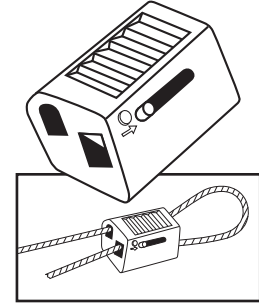

PACKAGING: BULK.

NOTES: CABLE ADJUSTERS ARE LIGHTWEIGHT, SELF-LOCKING AND RE-USABLE. NO SPECIAL TOOLS OR SETTING KEYS REQUIRED. BOTH 1/16" AND 1/8" ADJUSTERS MAY ALSO BE USED WITH 3/32" BARE (7 X 7) CABLE WITH A 150 LBS SAFE WORKING LOAD LIMIT. **WARNING:** USE ONLY ON BARE CABLE (WIRE ROPE) IN DRY, INDOOR LOCATIONS. DO NOT USE ON COATED CABLE. SUSPENSION OF OBJECTS AT ANGLES REDUCES THE SAFE WORKING LOAD LIMITS (CALL FOR DETAILS).

<u>PART #</u>	<u>CTN QTY</u>	<u>DESCRIPTION</u>	<u>WT PER/M</u>
105119	1,000	FOR USE WITH 1/32" BARE (3 X 7) CABLE, 20 LBS SAFE WORKING LOAD LIMIT.	25 L bs
105120	500	FOR USE WITH 1/16" BARE (7 X 7) CABLE, 75 LBS SAFE WORKING LOAD LIMIT.	46 L bs
105121	250	FOR USE WITH 1/8" BARE (7 X 7) CABLE, 250 LBS SAFE WORKING LOAD LIMIT.	112 L bs

K-RIZE CABLE & ADJUSTER KITS

EACH KIT IS SEALED IN A CLEAR POLY BAG AND INCLUDES ONE 1/16" DIA. K-RIZE CABLE ADJUSTER AND ONE 1/16" DIA (7 X 7) GALVANIZED CABLE WITH LOOP (3/4" LENGTH) ON ONE END.

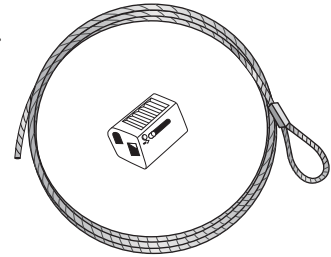

PACKAGING: BULK.

NOTES: OUR HIGHLY POPULAR SELF-LOCKING CABLE ADJUSTER WITH A LOOPED END CABLE TOGETHER IN A CONVENIENT KIT. ADJUST HEIGHT OF SIGNS EASILY WITH NO TOOLS REQUIRED. 1/16" DIA CABLE IS STRONG AND HOLDS UP TO 75 LBS. OTHER CABLE LENGTHS AVAILABLE UPON REQUEST. **WARNING:** USE ONLY IN DRY, INDOOR LOCATIONS. SUSPENSION OF OBJECTS AT ANGLES REDUCES THE SAFE WORKING LOAD LIMITS (CALL FOR DETAILS).

<u>PART #</u>	<u>CTN QTY</u>	<u>DESCRIPTION</u>	<u>WT PER/M</u>
105125	100	ONE K-RIZE AND ONE 5 FT. LONG CABLE	88 L bs
105126	100	ONE K-RIZE AND ONE 10 FT. LONG CABLE	124 L bs
105127	100	ONE K-RIZE AND ONE 15 FT. LONG CABLE	159 L bs
105128	100	ONE K-RIZE AND ONE 20 FT. LONG CABLE	196 L bs
105129	100	ONE K-RIZE AND ONE 30 FT. LONG CABLE	268 L bs

METAL JACK CHAIN

SINGLE JACK CHAIN, STEEL, BRIGHT GALVANIZED ON PLASTIC SPOOLS.
 #16 (.062 WIRE DIAMETER), #14 (.080 WIRE DIAMETER), #12 (.105 WIRE DIAMETER).



PACKAGING: SINGLE PLASTIC SPOOLS.

NOTES: VERY POPULAR FOR HANGING SIGNS AND OTHER ITEMS OF MEDIUM WEIGHT.
 CUSTOM LENGTHS AND KITS WITH "S" HOOKS AVAILABLE.

<u>PART #</u>	<u>MAXIMUM WORKING LOAD</u>	<u>CTN QTY</u>	<u>DESCRIPTION</u>	<u>WT PER EA</u>
104001	10 Lbs	1 Roll	#16 TRADE SIZE X 250' LONG	8.0 Lbs
104002	16 Lbs	1 Roll	#14 TRADE SIZE X 250' LONG	12.0 Lbs
104003	29 Lbs	1 Roll	#12 TRADE SIZE X 100' LONG	9.0 Lbs

METAL JACK CHAIN KIT

EACH KIT IS SEALED IN A CLEAR POLY BAG AND INCLUDES TWO #16 (.062 WIRE DIAMETER) X 48" LONG CHAINS AND FOUR 1" LONG (.080 WIRE DIAMETER) "S" HOOKS – STEEL, BRIGHT GALVANIZED.

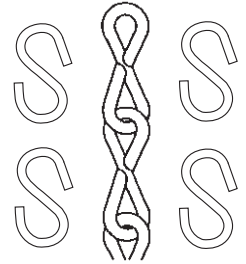

PACKAGING: BULK.

NOTES: OUR MOST POPULAR CHAIN AND "S" HOOKS PACKAGED IN A CONVENIENT KIT.
 HANG SIGNS OR DISPLAYS EASILY AND WITH CONFIDENCE. OTHER LENGTHS OR BLACK FINISH ALSO AVAILABLE.

<u>PART #</u>	<u>CTN QTY</u>	<u>DESCRIPTION</u>	<u>WT PER M</u>
104014	150	TWO 48" CHAINS & FOUR "S" HOOKS IN A BAG	265 Lbs

STEEL CABLE (WIRE ROPE) CUTTER

USE TOOL FOR HAND CUTTING WIRE ROPE AND JACK CHAIN UP TO 3/16" DIAMETER. HIGH QUALITY ALLOY STEEL WITH FORMED VINYL COATED HANDLES.

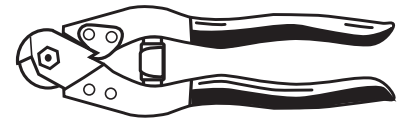

PACKAGING: SINGLE TOOL.

NOTES: TOP QUALITY, POCKET SIZED CUTTER. TRIANGULAR SHEAR CUT BLADES ALLOW FOR A CLEAN, SHARP END CUT WITHOUT CRUSHING, DEFORMING OR FRAYING.

<u>PART #</u>	<u>CTN QTY</u>	<u>DESCRIPTION</u>	<u>WT PER EA</u>
105050	1 TOOL	CUTS UP TO 3/16" DIA. 8" OVERALL LENGTH.	0.7 Lbs

SINGLE CAVITY HAND SWAGER

USE TOOL FOR HAND COMPRESSION OF 1/16" ALUMINUM AND COPPER CABLE SLEEVES (CRIMPS) AND STOPS. MADE OF HIGH GRADE TOOL STEEL, ZINC PLATED WITH FORMED VINYL COVERED HANDLES.

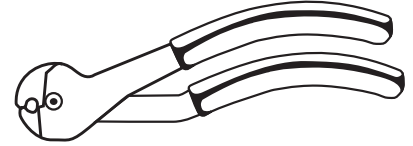

PACKAGING: SINGLE TOOL.

NOTES: OUR MOST ECONOMICAL CABLE TOOL. TOOL IS NOT DESIGNED FOR CABLE CUTTING. MAKE THREE PRESSES (SWAGED AREAS) PER SLEEVE. **WARNING:** SWAGING OF FITTINGS DIRECTLY OVER COATED WIRE ROPE WILL RESULT IN SEVERELY REDUCED HOLDING POWER.

<u>PART #</u>	<u>CTN QTY</u>	<u>DESCRIPTION</u>	<u>WT PER/EA</u>
105051	1 TOOL	SWAGES 1/16". 8" OVERALL LENGTH.	0.6 Lbs

THREE CAVITY HAND SWAGER

USE TOOL FOR HAND COMPRESSION OF 1/32", 3/64" AND 1/16" ALUMINUM AND COPPER CABLE SLEEVES (CRIMPS) AND STOPS. TOOL HAS BUILT-IN CABLE CUTTER WITH HEAT TREATED FORGED ALLOY STEEL JAWS.

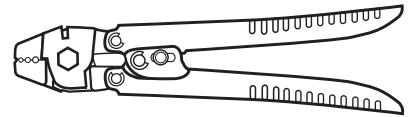

PACKAGING: SINGLE TOOL.

NOTES: MULTI-CAVITY TOOL FOR USE ON A VARIETY OF COMMON, SMALLER DIAMETER CABLES. MAKE THREE PRESSES (SWAGED AREAS) PER SLEEVE. **WARNING:** SWAGING OF FITTINGS DIRECTLY OVER COATED WIRE ROPE WILL RESULT IN SEVERELY REDUCED HOLDING POWER.

<u>PART #</u>	<u>CTN QTY</u>	<u>DESCRIPTION</u>	<u>WT PER/EA</u>
105052	1 TOOL	SWAGES 1/32", 3/64", AND 1/16". 10" OVERALL LENGTH.	0.9 Lbs

FIVE CAVITY HEAVY DUTY SWAGER

USE TOOL FOR HAND COMPRESSION OF 1/16", 3/32", 1/8", 5/32" AND 3/16" ALUMINUM AND COPPER CABLE SLEEVES (CRIMPS) AND STOPS. TOOL HAS BUILT-IN CABLE CUTTER (7/32" MAXIMUM CUT) WITH HEAT TREATED FORGED ALLOY STEEL JAWS.



PACKAGING: SINGLE TOOL.

NOTES: MULTI-CAVITY TOOL FOR USE ON A VARIETY OF COMMON, LARGER DIAMETER CABLES. MAKE THREE PRESSES (SWAGED AREAS) PER SLEEVE. **WARNING:** SWAGING OF FITTINGS DIRECTLY OVER COATED WIRE ROPE WILL RESULT IN SEVERELY REDUCED HOLDING POWER.

<u>PART #</u>	<u>CTN QTY</u>	<u>DESCRIPTION</u>	<u>WT PER/EA</u>
105053	1 TOOL	SWAGES 1/16", 3/32", 1/8", 5/32" AND 3/16". 24" OVERALL LENGTH	7.3 Lbs

SINGLE END ECONOMY WRENCHES

1" WIDE X 3" LONG, 16 GAUGE COLD ROLLED FLAT STEEL-ZINC PLATED. FOR LIGHT DUTY USE ON COMMON HEX BOLTS AND NUTS SIZES 6-32 THRU 3/8" DIAMETER.

PACKAGING: BULK.

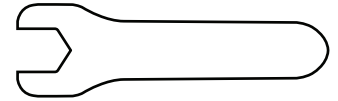

NOTES: OUR MOST ECONOMICAL HEX WRENCH (A.K.A. SINGLE-USE OR DISPOSABLE STYLE). INCLUDE IN HARDWARE KITS WHERE LIGHT DUTY ASSEMBLY IS REQUIRED. WRENCH SIZES ARE BASED UPON HEX WIDTH ACROSS FLATS OF NUTS AND BOLTS – NOT DIAMETER.

<u>PART #</u>	<u>CTN QTY</u>	<u>DESCRIPTION</u>	<u>WT PER/M</u>
105060	1,000	1/4" HEX WIDTH ACROSS FLATS	35.1 L bs
105061	1,000	5/16" HEX WIDTH ACROSS FLATS	34.8 L bs
105062	1,000	3/8" HEX WIDTH ACROSS FLATS	34.6 L bs
105063	1,000	7/16" HEX WIDTH ACROSS FLATS	34.4 L bs
105064	1,000	1/2" HEX WIDTH ACROSS FLATS	34.1 L bs

COMBINATION ECONOMY WRENCH

1-1/4" WIDE X 3-3/8" LONG, 16 GAUGE COLD ROLLED FLAT STEEL-ZINC PLATED. FOR LIGHT DUTY USE ON COMMON HEX BOLTS AND NUTS SIZES 1/4" THRU 3/8" DIAMETER.

PACKAGING: BULK.

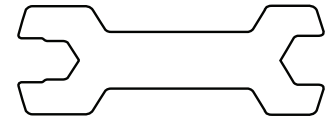

NOTES: AN ECONOMICAL, DOUBLE ENDED MULTI-SIZE RANGE HEX WRENCH (A.K.A. SINGLE-USE OR DISPOSABLE STYLE). INCLUDE IN HARDWARE KITS WHERE LIGHT DUTY ASSEMBLY IS REQUIRED. WRENCH SIZES ARE BASED UPON HEX WIDTH ACROSS FLATS OF NUTS AND BOLTS – NOT DIAMETER.

<u>PART #</u>	<u>CTN QTY</u>	<u>DESCRIPTION</u>	<u>WT PER/M</u>
105065	1,000	7/16", 1/2", 9/16" HEX WIDTH ACROSS FLATS	42.9 L bs

ECONOMY SCREWDRIVERS

HANDLES ARE MADE OF 1" O.D. BLACK POLYPROPYLENE MATERIAL. ROUND BLADES ARE MADE OF 15/64" DIA. HEAT TREATED STEEL. ALSO AVAILABLE WITH SLOTTED, TORX OR SQUARE DRIVE BLADES.

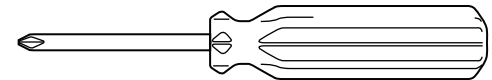

PACKAGING: BULK.

NOTES: OUR MOST ECONOMICAL SCREWDRIVERS. INCLUDE IN HARDWARE KITS. LARGE COMFORTABLE PLASTIC HANDLES OFFER A SECURE GRIP AND SOLID TURNING POWER. #2 DRIVE FITS MOST SCREWS 5-40 THRU 10-24 DIAMETER. #3 DRIVE FITS MOST SCREWS 12-24 THRU 1/4-20 DIAMETER.

<u>PART #</u>	<u>CTN QTY</u>	<u>DRIVE</u>	<u>OVERALL LENGTH</u>	<u>HANDLE LENGTH</u>	<u>BLADE LENGTH</u>	<u>WT PER/M</u>
105075	500	#2	3"	1-3/4"	1-1/4"	60 L bs
105076	500	#2	4"	1-3/4"	2-1/4"	68 L bs
105077	250	#2	6"	3-3/4"	2-1/4"	117 L bs
105078	250	#3	6"	3-3/4"	2-1/4"	117 L bs

UPRIGHT FLIP INSERTS

FOR USE ON GONDOLAS AND WAREHOUSE PALLET RACKS. BOTH THREADED NUT INSERTS (.100 THICK) AND SCREWS ARE ZINC PLATED STEEL. SCREWS HAVE SLOTTED/PHILLIPS COMBINATION DRIVE PAN HEADS. PARTS COME NON-ASSEMBLED WITH INSERTS AND MATING SCREWS IN THE SAME BAG.

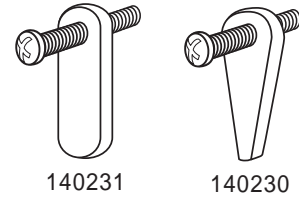

PACKAGING: BAGGED 100 PER.

NOTES: SECURELY ATTACH SIGNS, DISPLAYS AND FIXTURES ONTO COMMON UPRIGHT SLOTS FOUND IN GONDOLAS AND WAREHOUSE PALLET RACKING. SIMPLY PUT THE SCREW THROUGH FIXTURE INTO THREADED INSERT NUT AND ENGAGE UPRIGHT, THEN TIGHTEN.

<u>PART #</u>	<u>CTN QTY</u>	<u>TYPE</u>	<u>DESCRIPTION</u>	<u>WT PER/M</u>
140231	2,500	GONDOLA	NUT: 10-32, 1-3/16"L X .350 W SCREW: 10-32 X 1"L WITH .312 HD O.D. FITS GONDOLA SLOT: 3/4"L X 3/8"W	17.9 L bs
140230	1,000	PALLET RACK	NUT: 1/4-20, 1-3/16"L X .500 W SCREW: 1/4-20 X 1-1/4"L WITH .414 HD O.D. FITS WAREHOUSE TEARDROP STYLE HOLES	25.8 L bs

WALL ANCHOR - LIGHT DUTY CONICAL

USE IN COMBINATION WITH A SELF TAPPING OR WOOD SCREW (SOLD SEPARATELY). TO INSTALL, INSERT ANCHOR IN DRILLED HOLE, INSERT SCREW THROUGH FIXTURE INTO ANCHOR AND TIGHTEN. MADE OF POLYPROPYLENE.



PACKAGING: BULK.

NOTES: OUR MOST ECONOMICAL ANCHOR FOR USE IN DRY WALL, CONCRETE, WOOD OR BRICK. ANCHOR HAS HORIZONTAL FINS THAT EXPAND AS SCREW IS DRIVEN IN. EXCELLENT FOR USE WITH LIGHTWEIGHT MENU BOARDS, LITERATURE HOLDERS AND SIGNS.

<u>PART #</u>	<u>CTN QTY</u>	<u>SCREW SIZE</u>	<u>LENGTH</u>	<u>DRILL SIZE</u>	<u>COLOR</u>	<u>WT PER/M</u>
140210	10,000	#6-8	7/8"	3/16"	BLUE	0.6 L bs
140211	10,000	#10-12	1"	1/4"	RED	1.1 L bs

WALL ANCHOR - MEDIUM DUTY ZIP-IT®

SELF DRILLING POINT CUTS RIGHT INTO 3/8"-5/8" DRY WALL BY SIMPLY SCREWING IT IN. FLUSH, LOW PROFILE PHILLIPS COUNTERSINKING HEAD. USE IN COMBINATION WITH A SELF TAPPING SCREW OR SCREW EYE (SOLD SEPARATELY). AVAILABLE IN BOTH NATURAL NYLON AND ZINC ALLOY MATERIAL.

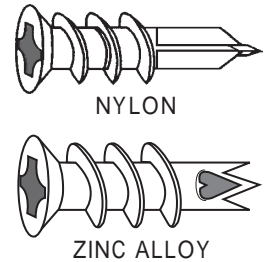

PACKAGING: BULK.

NOTES: NO PRE-DRILLING OF HOLE REQUIRED. SIMPLY SCREW ANCHOR INTO DRY WALL THEN INSERT SCREW THROUGH FIXTURE INTO ANCHOR AND TIGHTEN. DEEP COARSE THREADS CREATE STRONG ENGAGEMENT AND HOLD. REPLACES PLASTIC CONICAL ANCHORS WHERE MORE STRENGTH IS REQUIRED. MINIMUM REQUIRED SCREW LENGTH ENGAGEMENT FOR BOTH #6 AND #8 IS 3/4".

<u>PART #</u>	<u>CTN QTY</u>	<u>SCREW SIZE</u>	<u>LENGTH</u>	<u>MATERIAL</u>	<u>WT PER/M</u>
140200	5,000	#6 X 1"	1-5/16"	NYLON	1.6 L bs
140202	5,000	#6 X 1"	1-1/16"	ZC ALLOY	5.6 L bs
140201	5,000	#8 X 1"	1-11/16"	NYLON	3.8 L bs
140203	1,000	#8 X 1"	1-5/16"	ZC ALLOY	12.8 L bs

WALL ANCHOR - HEAVY DUTY TOGGLE WING

USE IN COMBINATION WITH A MACHINE SCREW OR EYE BOLT (SOLD SEPARATELY). SPRING WING TYPE HOLLOW WALL ANCHOR MADE OF TWO WINGS CONNECTED BY A THREADED NUT AND A COIL SPRING. STEEL, ZINC PLATED. WINGS OPEN AUTOMATICALLY BEHIND THE WALL TO PREVENT PULL-THROUGH.

PACKAGING: BULK.

NOTES: GREAT FOR USE IN DRY WALL, PANELING, BLOCK AND HOLLOW BASE DISPLAY CONSTRUCTION WHERE EXTRA HOLDING POWER IS REQUIRED. TO INSTALL, THREAD TOGGLE ON SCREW, FOLD WINGS BACK AND INSERT ANCHOR THROUGH DRILLED HOLE UNTIL WINGS SPRING OPEN, THEN TIGHTEN SCREW. IN HARD/SOLID MATERIALS, DRILL THE HOLE 1/16" LARGER.

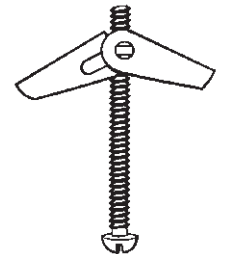

<u>PART #</u>	<u>CTN QTY</u>	<u>SCREW SIZE</u>	<u>LENGTH</u>	<u>DRILL SIZE</u>	<u>WT PER/M</u>
140220	5,000	6-32 (1/8")	1-1/2"	3/8"	6.8 L bs
140222	2,000	10-24 (3/16")	2-1/8"	1/2"	15.2 L bs
140223	1,200	1/4-20 (1/4")	2-1/8"	5/8"	22.8 L bs

LOCKING STRAPS (CABLE TIES)



A VARIETY OF LENGTHS AND WIDTHS AVAILABLE THAT EMPLOY A RATCHETING MECHANISM WHICH ALLOWS FOR LOCKING AS NECESSARY FOR BUNDLING ITEMS TOGETHER. SOLID STYLE. NYLON 6/6 NATURAL.

PACKAGING: BAGGED AS SHOWN BELOW.

NOTES: FAST INEXPENSIVE WAY TO SECURE SIGNS AND OTHER ITEMS. SIMPLY ADJUST TO DESIRED SIZE AND LOCK PERMANENTLY IN PLACE. ALSO AVAILABLE IN **BLACK**.

<u>PART #</u>	<u>CTN QTY</u>	<u>BAG QTY</u>	<u>WIDTH</u>	<u>LENGTH</u>	<u>TENSILE STRENGTH</u>	<u>WT PER/M</u>
130500	70,000	1,000	.094	4"	18#	0.9 L bs
130501	40,000	1,000	.094	6"	18#	1.0 L bs
130502	35,000	1,000	.094	8"	18#	1.3 L bs
130503	30,000	1,000	.140	5"	40#	1.7 L bs
130504	18,000	1,000	.140	8"	40#	2.5 L bs
130505	16,000	1,000	.178	7"	50#	3.0 L bs
130506	10,000	1,000	.178	11"	50#	4.4 L bs
130507	9,000	1,000	.178	14"	50#	5.6 L bs
130508	7,000	1,000	.300	8"	120#	8.7 L bs
130509	4,500	100	.300	15"	120#	14.0 L bs
130510	2,000	100	.340	24"	175#	32.0 L bs
130512	1,000	100	.340	36"	175#	44.0 L bs
130513	1,000	100	.340	48"	175#	60.0 L bs

POLE SIGN LOCKING STRAP KITS

EACH KIT IS SEALED IN A CLEAR POLY BAG AND INCLUDES TWO PIECES OF OUR HIGHLY POPULAR #130512, .340 WIDE X 36" LONG CABLE TIES AND FOUR PIECES OF OUR STANDARD #130504, .140 WIDE X 8" LONG CABLE TIES. NATURAL OR **BLACK** NYLON.

PACKAGING: BULK.

NOTES: FAST INEXPENSIVE WAY TO SECURE BOTH INDOOR AND OUTDOOR SIGNS BACK TO BACK ON MOST ROUND OR SQUARE POLES. HANG CORPLAS OR CORRUGATED SIGNS WITH CONFIDENCE. OUR MOST POPULAR CABLE TIES PRE-PACKAGED IN A CONVENIENT KIT. BACK TO BACK SIGNS: 36" LONG TIES EASILY SECURES TO THE POLE WHILE 8" LONG TIES CINCH THE CORNERS TOGETHER. NO TOOLS REQUIRED.

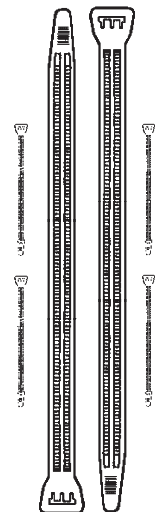

<u>PART #</u>	<u>CTN QTY</u>	<u>DESCRIPTION</u>	<u>WT PER/M</u>
130525	250	TWO 36" AND FOUR 8" TIES IN A BAG-NATURAL	99.0 L bs
130525B	250	TWO 36" AND FOUR 8" TIES IN A BAG-BLACK	99.0 L bs

PREMIUM SUCTION CUP - MUSHROOM HD

HIGH QUALITY USA MADE CUP WITH UNIQUE REINFORCING RINGS FOR ADDED STRENGTH AND LONG TERM HOLDING POWER. CLEAR UV RESISTANT PVC THAT WON'T YELLOW OR BECOME BRITTLE. FOR USE IN HOT OR COLD EXTREMES.

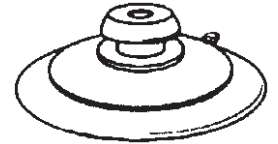

PACKAGING: BULK.

NOTES: IDEAL FOR KEYHOLE OPENINGS, HOLES OR GROMMETS. SIMPLIFIED DESIGN ACCOMMODATES A WIDE RANGE OF SIGNS, POSTERS OR SELF HANGING PRODUCTS. APPLY TO CLEAN, NON-POROUS SURFACE FOR BEST RESULTS. ADDITIONAL SIZES AVAILABLE.

<u>PART #</u>	<u>CTN QTY</u>	<u>HEAD O.D.</u>	<u>NECK O.D.</u>	<u>NECK LENGTH</u>	<u>DESCRIPTION</u>	<u>WT PER/M</u>
130601	3,000	.275	.150	.080	3/4" DIAMETER (MINI)	1.7 Lbs
130602	1,000	.395	.254	.068	1-1/8" DIAMETER (SMALL)	5.4 Lbs
130603	500	.595	.346	.100	1-3/4" DIAMETER (MEDIUM)	14.8 Lbs
130604	500	.584	.332	.078	2-1/2" DIAMETER (LARGE)	31.1 Lbs

PREMIUM SUCTION CUP - PILOT HOLE

HIGH QUALITY USA MADE CUP WITH UNIQUE REINFORCING RINGS FOR ADDED STRENGTH AND LONG TERM HOLDING POWER. CLEAR UV RESISTANT PVC THAT WON'T YELLOW OR BECOME BRITTLE. FOR USE IN HOT OR COLD EXTREMES.

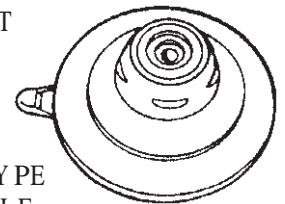

PACKAGING: BULK.

NOTES: 3/32" DIA. TOP PILOT HOLE CAN BE SCREWED INTO WITH COMMON TYPE "B" STEEL TAPPING SCREW FOR PERMANENT MOUNT OR ACCEPTS PRESS-IN MALE THUMB TACK (SEE PAGE 29) FOR HOLDING SIGNS FIRM. DESIGNED TO HANG A VARIETY OF PRODUCTS. APPLY TO CLEAN, NON-POROUS SURFACE FOR BEST RESULTS. ADDITIONAL SIZES AVAILABLE

<u>PART #</u>	<u>CTN QTY</u>	<u>DESCRIPTION</u>	<u>WT PER/M</u>
130605	1,000	3/4" DIAMETER (MINI)	1.7 Lbs
130606	1,000	1-1/8" DIAMETER (SMALL)	6.6 Lbs
130607	500	1-3/4" DIAMETER (MEDIUM)	14.9 Lbs
130608	500	2-1/2" DIAMETER (LARGE)	31.3 Lbs

PREMIUM SUCTION CUP - METAL HOOK

HIGH QUALITY USA MADE CUP WITH UNIQUE REINFORCING RINGS FOR ADDED STRENGTH AND LONG TERM HOLDING POWER. CLEAR UV RESISTANT PVC THAT WON'T YELLOW OR BECOME BRITTLE. FOR USE IN HOT OR COLD EXTREMES.

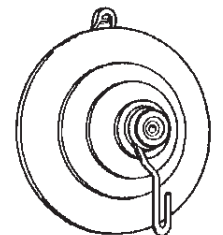

PACKAGING: BULK.

NOTES: STRONG CORROSION RESISTANT PLATED STEEL HOOK IS IDEAL FOR WINDOW MOUNTED SIGNS OR SELF HANGING PRODUCTS. EASY ONE STEP HANGING. APPLY TO CLEAN, NON-POROUS SURFACE FOR BEST RESULTS. ADDITIONAL SIZES AVAILABLE.

<u>PART #</u>	<u>CTN QTY</u>	<u>DESCRIPTION</u>	<u>WT PER/M</u>
130609	3,000	3/4" DIAMETER (MINI)	3.2 Lbs
130610	1,000	1-1/8" DIAMETER (SMALL)	7.7 Lbs
130611	500	1-3/4" DIAMETER (MEDIUM)	18.2 Lbs
130612	500	2-1/2" DIAMETER (LARGE)	39.5 Lbs

HOOK & LOOP FASTENERS

TAPE OR COINS AVAILABLE IN CONTINUOUS 25 YARD LONG ROLLS HAVING PERMANENT RUBBER BASED ADHESIVE BACKING. WHITE OR BLACK DURABLE WOVEN NYLON MATERIAL. HOOK AND LOOP SOLD SEPARATELY. ADDITIONAL SIZES AND CUSTOM CUTS CAN BE MADE TO ORDER INCLUDING MATED SETS, KISS-CUT ROLLS OR SPECIAL PACKAGING.

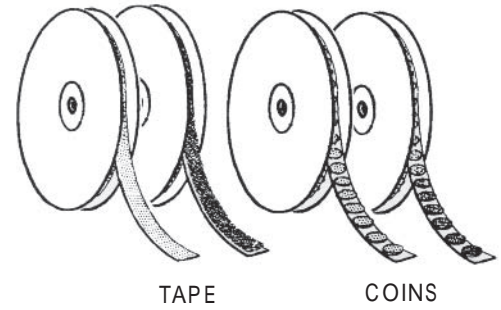

PACKAGING: 25 YARD ROLLS.

NOTES: HIGHLY POPULAR FOR NUMEROUS POP APPLICATIONS AND SIGNS WITH CHANGING MESSAGES. HOOK AND LOOP FASTENERS PROVIDE HOLDING POWER WITH FLEXIBILITY AND FAST SET-UP TIME FOR IMMEDIATE USE. SIMPLY PEEL TAPE OR COINS FROM PAPER/CLEAR FILM LINER AND STICK TO ANY CLEAN, SMOOTH, DRY SURFACE – BEST SUITED FOR INDOOR USE. COINS ARE OTHERWISE KNOWN AS BUTTONS, TABS OR DOTS.

<u>PART #</u>	<u>CTN QTY</u>	<u>ROLL QTY</u>	<u>TYPE</u>	<u>DESCRIPTION</u>	<u>WT PER/EA</u>
150502	20 ROLLS	25 YDS	TAPE	5/8" HOOK -WHITE	0.7 L bs
150503	20 ROLLS	25 YDS	TAPE	5/8" LOOP-WHITE	0.7 L bs
150502B	20 ROLLS	25 YDS	TAPE	5/8" HOOK -BLACK	0.7 L bs
150503B	20 ROLLS	25 YDS	TAPE	5/8" LOOP-BLACK	0.7 L bs
150504	20 ROLLS	25 YDS	TAPE	3/4" HOOK -WHITE	0.9 L bs
150505	20 ROLLS	25 YDS	TAPE	3/4" LOOP-WHITE	0.9 L bs
150504B	20 ROLLS	25 YDS	TAPE	3/4" HOOK -BLACK	0.9 L bs
150505B	20 ROLLS	25 YDS	TAPE	3/4" LOOP-BLACK	0.9 L bs
150506	16 ROLLS	25 YDS	TAPE	1" HOOK -WHITE	1.1 L bs
150507	16 ROLLS	25 YDS	TAPE	1" LOOP-WHITE	1.1 L bs
150506B	16 ROLLS	25 YDS	TAPE	1" HOOK -BLACK	1.1 L bs
150507B	16 ROLLS	25 YDS	TAPE	1" LOOP-BLACK	1.1 L bs
150602	24 ROLLS	1,440 PCS	COINS	1/2" HOOK -WHITE	0.5 L bs
150603	24 ROLLS	1,440 PCS	COINS	1/2" LOOP-WHITE	0.5 L bs
150602B	24 ROLLS	1,440 PCS	COINS	1/2" HOOK -BLACK	0.5 L bs
150603B	24 ROLLS	1,440 PCS	COINS	1/2" LOOP-BLACK	0.5 L bs
150606	16 ROLLS	1,028 PCS	COINS	3/4" HOOK -WHITE	0.7 L bs
150607	16 ROLLS	1,028 PCS	COINS	3/4" LOOP-WHITE	0.7 L bs
150606B	16 ROLLS	1,028 PCS	COINS	3/4" HOOK -BLACK	0.7 L bs
150607B	16 ROLLS	1,028 PCS	COINS	3/4" LOOP-BLACK	0.7 L bs
150608	16 ROLLS	900 PCS	COINS	7/8" HOOK -WHITE	0.8 L bs
150609	16 ROLLS	900 PCS	COINS	7/8" LOOP-WHITE	0.8 L bs
150608B	16 ROLLS	900 PCS	COINS	7/8" HOOK -BLACK	0.8 L bs
150609B	16 ROLLS	900 PCS	COINS	7/8" LOOP-BLACK	0.8 L bs

ALUMINUM BINDER POST & SCREWS

EACH BINDER POST ASSEMBLY CONSISTS OF ONE POST (.203 DIA X .415 HEAD O.D. - UNSLOTTED) AND ONE SCREW (8-32 THREAD DIA X .415 HEAD O.D. - SLOTTED) - ALUMINUM, FOR USE IN 7/32" HOLES.



PACKAGING: BULK (POST & SCREW SOLD SEPARATELY).

NOTES: LOW PROFILE, MATCHING HEAD ON BOTH THE POST AND THE SCREW ALLOW FOR A NICE CLEAN LOOK. ALUMINUM MATERIAL IS MUCH STRONGER AND MORE DURABLE THAN NYLON POST AND SCREW IMITATIONS. *OPTIONAL UNSLOTTED DRIVE-IN TYPE PERMANENT LOCKING SCREW ALSO AVAILABLE. **OPTIONAL SLOTTED HAND PRESS-IN RAPID ASSEMBLY SCREW FOR LIGHTWEIGHT APPLICATIONS ALSO AVAILABLE.

<u>PART #</u>	<u>CTN QTY</u>	<u>DESCRIPTION</u>	<u>WT PER/M</u>
100050	1,000	3/16" SCREW (FOR 1/8" POST)	0.7 Lbs
100051	1,000	1/4" SCREW (FOR 3/16" & 1/4" POSTS)	0.8 Lbs
100052	1,000	3/8" SCREW (FOR ALL POSTS 3/8" & LONGER)	1.0 Lbs
100043**	1,000	3/8" PUSH-IN SCREW (GRAY PLASTIC)	0.5 Lbs
100049*	1,000	3/8" PERMALOCK (NICKEL PLATED STEEL)	2.5 Lbs
100048	1,000	1/8" POST LENGTH, OPEN END	0.7 Lbs
100053	1,000	3/16" POST LENGTH, OPEN END	0.8 Lbs
100054	1,000	1/4" POST LENGTH, OPEN END	0.9 Lbs
100055	1,000	3/8" POST LENGTH, OPEN END	1.0 Lbs
100056	1,000	1/2" POST LENGTH, CLOSED END	1.2 Lbs
100057	1,000	5/8" POST LENGTH, CLOSED END	1.6 Lbs
100058	1,000	3/4" POST LENGTH, CLOSED END	2.0 Lbs
100059	1,000	7/8" POST LENGTH, CLOSED END	2.2 Lbs
100060	1,000	1" POST LENGTH, CLOSED END	2.8 Lbs
100061	500	1-1/4" POST LENGTH, CLOSED END	3.6 Lbs
100062	500	1-1/2" POST LENGTH, CLOSED END	4.4 Lbs
100063	500	1-3/4" POST LENGTH, CLOSED END	5.2 Lbs
100064	500	2" POST LENGTH, CLOSED END	6.0 Lbs
100065	250	2-1/4" POST LENGTH, CLOSED END	6.7 Lbs
100066	250	2-1/2" POST LENGTH, CLOSED END	7.5 Lbs
100067	250	2-3/4" POST LENGTH, CLOSED END	8.3 Lbs
100068	250	3" POST LENGTH, CLOSED END	9.2 Lbs
100069	250	3-1/4" POST LENGTH, CLOSED END	10.0 Lbs
100070	250	3-1/2" POST LENGTH, CLOSED END	10.8 Lbs
100072	250	4" POST LENGTH, CLOSED END	12.3 Lbs
100073	250	4-1/2" POST LENGTH, CLOSED END	13.8 Lbs
100074	250	5" POST LENGTH, CLOSED END	15.3 Lbs
100076	250	6" POST LENGTH, CLOSED END	18.3 Lbs

OPTIONAL CLOSED END SHORT LENGTH ALUMINUM BINDER POST

<u>PART #</u>	<u>CTN QTY</u>	<u>DESCRIPTION</u>	<u>WT PER/M</u>
100045	1,000	1/4" POST LENGTH, CLOSED END (SPECIAL)	1.0 Lbs
100047	1,000	3/8" POST LENGTH, CLOSED END (SPECIAL)	1.2 Lbs

NOTES: 1/4" CLOSED END POST ACCEPTS #100050 3/16" SCREW, 3/8" CLOSED END POST ACCEPTS #100051 1/4" SCREW.

ALUMINUM BINDER POST EXTENSIONS

.203 DIA. (MATCHES BINDER POSTS SHOWN ON PAGE 26) WITH 8-32 DIA.
MALE AND FEMALE ENDS - ALUMINUM, FOR USE IN 7/32" HOLES.



PACKAGING: BULK.

NOTES: WHEN USED IN CONJUNCTION WITH ALUMINUM BINDER POSTS,
EXTENSIONS ADD LENGTH IN ORDER TO INCREASE BINDING CAPACITY AS NEEDED.

<u>PART #</u>	<u>CTN QTY</u>	<u>DESCRIPTION</u>	<u>WT PER/M</u>
100030	1,000	1/4" LONG EXTENSION	0.7 L bs
100031	1,000	1/2" LONG EXTENSION	1.3 L bs
100032	1,000	3/4" LONG EXTENSION	2.0 L bs
100033	1,000	1" LONG EXTENSION	2.8 L bs

BLACK ALUMINUM BINDER POST & SCREWS

BLACK ANODIZED BINDER POST ASSEMBLY CONSISTING OF ONE POST (.203 DIA X .415 HEAD O.D. - UNSLOTTED) AND ONE SCREW (8-32 THREAD DIA X .415 HEAD O.D. - SLOTTED) - ALUMINUM, FOR USE IN 7/32" HOLES.



PACKAGING: BULK (POST & SCREW SOLD SEPARATELY).

NOTES: DURABLE BLACK ANODIZED FINISH ON OUR MOST
POPULAR SIZES OF ALUMINUM BINDER POSTS AND MATCHING SCREWS. IT SHOULD BE NOTED
THAT DURING THE ANODIZING PROCESS A VERY SMALL, RANDOMLY LOCATED CONTACT POINT
WILL REVEAL A BARE ALUMINUM SPOT. OTHER SIZES AVAILABLE IN **BLACK** UPON REQUEST.

<u>PART #</u>	<u>CTN QTY</u>	<u>DESCRIPTION</u>	<u>WT PER/M</u>
100050B	1,000	3/16" SCREW (FOR 1/8" POST)	0.7 L bs
100051B	1,000	1/4" SCREW (FOR 3/16" & 1/4" POSTS)	0.8 L bs
100052B	1,000	3/8" SCREW (FOR ALL POSTS 3/8" & LONGER)	1.0 L bs
100048B	1,000	1/8" POST LENGTH, OPEN END	0.7 L bs
100053B	1,000	3/16" POST LENGTH, OPEN END	0.8 L bs
100054B	1,000	1/4" POST LENGTH, OPEN END	0.9 L bs
100055B	1,000	3/8" POST LENGTH, OPEN END	1.0 L bs
100056B	1,000	1/2" POST LENGTH, CLOSED END	1.2 L bs
100057B	1,000	5/8" POST LENGTH, CLOSED END	1.6 L bs
100058B	1,000	3/4" POST LENGTH, CLOSED END	2.0 L bs
100060B	1,000	1" POST LENGTH, CLOSED END	2.8 L bs
100061B	500	1-1/4" POST LENGTH, CLOSED END	3.6 L bs
100062B	500	1-1/2" POST LENGTH, CLOSED END	4.4 L bs
100063B	500	1-3/4" POST LENGTH, CLOSED END	5.2 L bs
100064B	500	2" POST LENGTH, CLOSED END	6.0 L bs

BRASS BINDER POST & SCREWS

SOLID BRASS BINDER POST ASSEMBLY CONSISTING OF ONE POST (.203 DIA X .415 HEAD O.D. - UNSLOTTED) AND ONE SCREW (8-32 THREAD DIA X .415 HEAD O.D. - SLOTTED) FOR USE IN 7/32" HOLES. PARTS ARE PASSIVATED AND WAXED TO HELP PREVENT TARNISHING.



PACKAGING: BULK (POST & SCREW SOLD SEPARATELY).

NOTES: OUR MOST POPULAR SIZES OF BINDER POSTS AND SCREWS IN BRIGHT SOLID BRASS MATERIAL. LOW PROFILE MATCHING HEAD ON BOTH THE POST AND THE SCREW ALLOW FOR A NICE CLEAN LOOK. OTHER SIZES AVAILABLE UPON REQUEST.

<u>PART #</u>	<u>CTN QTY</u>	<u>DESCRIPTION</u>	<u>WT PER/M</u>
100350	1,000	3/16" SCREW (FOR 1/8" POST)	2.6 Lbs
100351	1,000	1/4" SCREW (FOR 3/16" & 1/4" POSTS)	3.0 Lbs
100342	1,000	5/16" SCREW (FOR ALL POSTS 3/8" & LONGER)	3.3 Lbs
100348	1,000	1/8" POST LENGTH, OPEN END	1.8 Lbs
100353	1,000	3/16" POST LENGTH, OPEN END	2.1 Lbs
100354	1,000	1/4" POST LENGTH, OPEN END	2.3 Lbs
100347	1,000	3/8" POST LENGTH, CLOSED END	3.6 Lbs
100356	1,000	1/2" POST LENGTH, CLOSED END	4.0 Lbs
100357	1,000	5/8" POST LENGTH, CLOSED END	5.3 Lbs
100358	1,000	3/4" POST LENGTH, CLOSED END	6.5 Lbs
100360	1,000	1" POST LENGTH, CLOSED END	8.7 Lbs
100361	500	1-1/4" POST LENGTH, CLOSED END	11.2 Lbs
100362	500	1-1/2" POST LENGTH, CLOSED END	13.8 Lbs
100363	500	1-3/4" POST LENGTH, CLOSED END	16.2 Lbs
100364	500	2" POST LENGTH, CLOSED END	18.6 Lbs

STEEL BARREL BOLTS & SCREWS

EACH BARREL BOLT ASSEMBLY CONSISTS OF ONE BOLT (.250 BARREL DIA X .438 HEAD O.D. - SLOTTED/PHILLIPS COMBINATION) AND ONE SCREW (10-24 THREAD DIA X .438 HEAD O.D. - SLOTTED/PHILLIPS COMBINATION) – ZINC PLATED STEEL, FOR USE IN 17/64" HOLES.

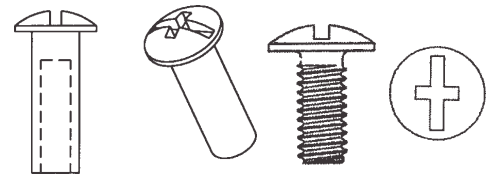

PACKAGING: BULK (BOLT & SCREW SOLD SEPARATELY).

NOTES: OTHERWISE KNOWN AS "SEX BOLTS". LOW PROFILE, MATCHING HEAD ON BOTH THE BOLT AND SCREW ALLOW FOR A NICE CLEAN LOOK. STEEL ZINC PLATED MATERIAL IS MUCH STRONGER THAN COMMON ALUMINUM BINDER POSTS.

<u>PART #</u>	<u>CTN QTY</u>	<u>DESCRIPTION</u>	<u>WT PER/M</u>
100242	1,000	5/16" SCREW (FITS ALL BARREL BOLTS)	4.5 Lbs
100254	1,000	1/4" BARREL LENGTH, SLOTTED OPEN END	3.8 Lbs
100255	1,000	3/8" BARREL LENGTH, COMBO CLOSED END	6.0 Lbs
100256	1,000	1/2" BARREL LENGTH, COMBO CLOSED END	6.4 Lbs
100257	1,000	5/8" BARREL LENGTH, COMBO CLOSED END	7.7 Lbs
100258	1,000	3/4" BARREL LENGTH, COMBO CLOSED END	9.6 Lbs
100260	1,000	1" BARREL LENGTH, COMBO CLOSED END	12.8 Lbs
100261	500	1-1/4" BARREL LENGTH, COMBO CLOSED END	16.2 Lbs
100262	500	1-1/2" BARREL LENGTH, COMBO CLOSED END	19.5 Lbs
100264	500	2" BARREL LENGTH, COMBO CLOSED END	26.3 Lbs

STEEL BARREL BOLT EXTENSION

.250 DIA. (MATCHES BARREL BOLTS SHOWN ON PAGE 28) WITH 10-24 DIA. MALE AND FEMALE ENDS - ZINC PLATED STEEL, FOR USE IN 17/64" HOLES.



PACKAGING: BULK.

NOTES: WHEN USED IN CONJUNCTION WITH ZINC PLATED STEEL BARREL BOLTS, EXTENSIONS ADD LENGTH IN ORDER TO INCREASE BINDING CAPACITY AS NEEDED.

<u>PART #</u>	<u>CTN QTY</u>	<u>DESCRIPTION</u>	<u>WT PER/M</u>
100231	1,000	1/2" LONG BARREL EXTENSION	5.3 Lbs

SNAP RIVET FASTENER

.320 HOLE SIZE (FEMALE) X .625 O.D. ROUND HEAD (MALE & FEMALE). COMPLETE ASSEMBLY REQUIRES TWO PIECES (BOTH MALE & FEMALE) -NYLON 6/6 NATURAL.

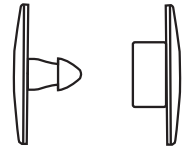

PACKAGING: BULK (SOLD BY PIECE, NOT SETS).

NOTES: COMBINATION OF TWO MATING PARTS (MALE & FEMALE) THAT PERMANENTLY LOCK TO CONNECT FLAT PANELS TOGETHER. SEPARATELY, MALE MAY ALSO BE USED IN CONJUNCTION WITH SUCTION CUPS AS A TAMPER RESISTANT THUMB TACK. ALSO AVAILABLE IN **BLACK**.

<u>PART #</u>	<u>CTN QTY</u>	<u>DESCRIPTION</u>	<u>WT PER/M</u>
120320	10,000	FEMALE (FITS ALL MALE LENGTHS)	0.9 Lbs
120325	10,000	MALE .170-.190 GRIP CAPACITY	0.7 Lbs
120327	10,000	MALE .220-.240 GRIP CAPACITY	0.8 Lbs
120329	10,000	MALE .320-.340 GRIP CAPACITY	0.9 Lbs

RATCHET RIVET FASTENER

.281 HOLE SIZE AVAILABLE IN TWO ROUND HEAD DIAMETERS (LARGE AND SMALL). COMPLETE ASSEMBLY REQUIRES TWO PIECES. NYLON 6/6 -NATURAL.

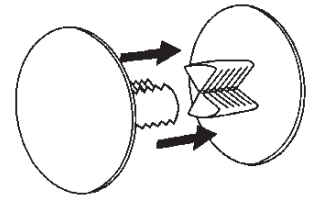

PACKAGING: BULK (SOLD BY PIECE, NOT SETS).

NOTES: SIMPLY PRESS TWO PIECES TOGETHER. SERRATED TEETH ADJUST TO A VARIETY OF LOCKING DEPTHS AND JOIN PANELS TOGETHER IN A SECURE AND PERMANENT MANNER. ALSO AVAILABLE IN **BLACK**.

<u>PART #</u>	<u>CTN QTY</u>	<u>DESCRIPTION</u>	<u>WT PER/M</u>
120300	10,000	.750 HD O.D. X .235-.297 GRIP CAPACITY	1.2 Lbs
120302	10,000	.750 HD O.D. X .346-.500 GRIP CAPACITY	1.4 Lbs
120303	10,000	.750 HD O.D. X .500-.812 GRIP CAPACITY	1.7 Lbs
120304	10,000	.750 HD O.D. X .780-1.38 GRIP CAPACITY	1.8 Lbs
120305	10,000	.406 HD O.D. X .235-.297 GRIP CAPACITY	0.4 Lbs
120307	10,000	.406 HD O.D. X .346-.500 GRIP CAPACITY	0.6 Lbs
120308	10,000	.406 HD O.D. X .500-.812 GRIP CAPACITY	0.7 Lbs
120309	10,000	.406 HD O.D. X .780-1.38 GRIP CAPACITY	0.8 Lbs

VIKING CLIP FASTENER - PUSH ON TYPE

.187 HOLE SIZE WITH 9/16" O.D. ROUND HEAD SCREW & PUSH-ON / SCREW-OFF WING NUT FASTENER - POLYCARBONATE - CLEAR OR BLACK. (PART # 120406 HAS A 5/8" LONG NON-THREADED SHOULDER).

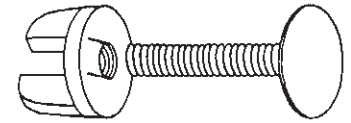

PACKAGING: BULK.

NOTES: TWO PIECE CONSTRUCTION (SCREW & WING NUT COMBINATION). VERSATILE WING NUT FASTENER CAN BE PUSHED ON FOR FAST ASSEMBLY. THIS CLIP IS EXTREMELY POPULAR FOR SIGN AND DISPLAY CONSTRUCTION. REMOVABLE AND REUSABLE.

<u>PART #</u>	<u>CTN QTY</u>	<u>DESCRIPTION</u>	<u>WT PER/M</u>
120401	6,000	3/4" GRIP CAPACITY (7/8" LONG SCREW)-CLEAR	3.9 Lbs
120402	6,000	3/4" GRIP CAPACITY (7/8" LONG SCREW)-BLACK	3.9 Lbs
120406	3,500	1-3/8" GRIP CAPACITY (1-1/2" LONG SCREW)-CLEAR	4.9 Lbs

QUICK-GRIP WASHER FASTENER

.187 HOLE SIZE WITH 9/16" O.D. ROUND HEAD SCREW & RETAINING WASHER FASTENER - POLYCARBONATE - CLEAR.

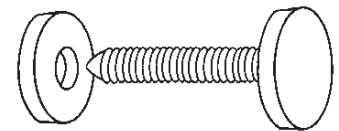

PACKAGING: BULK.

NOTES: TWO PIECE CONSTRUCTION (SCREW & RETAINING WASHER COMBINATION). FEATURES FAST ATTACHING "SLIDE-ON" RETAINING NUT FOR QUICK ASSEMBLY OF SIGNS AND DISPLAYS. PROVIDES A SECURE, NON-REMOVABLE HOLD.

<u>PART #</u>	<u>CTN QTY</u>	<u>DESCRIPTION</u>	<u>WT PER/M</u>
120403	6,000	1/2" GRIP CAPACITY (5/8" LONG SCREW)-CLEAR	2.2 Lbs
120404	6,000	3/4" GRIP CAPACITY (7/8" LONG SCREW)-CLEAR	2.5 Lbs

PERF SHELF UNIVERSAL FASTENERS

TWO HEAD STYLES TO CHOOSE FROM WITH BOTH HAVING .250 HOLE SIZE X .001-.187 GRIP CAPACITY X .500 SHANK LENGTH WITH .438 O.D. FLAT HEADS. PRE-ASSEMBLED TWO PIECE DESIGN. NYLON 6/6-NATURAL. ALSO AVAILABLE IN BLACK.

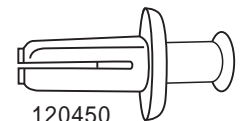

120450

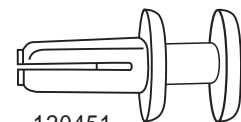

120451

PACKAGING: BULK.

NOTES: BOTH STYLES FIT MOST ROUND, SQUARE OR DIAMOND SHAPED PERFORATED SHELF HOLES AND CAN EASILY BE REMOVED AND RE-USED. SIMPLY PRESS PIN IN TO EXPAND LEGS THAT LOCK FIRMLY IN PLACE. THE LOW PROFILE STYLE OFFERS A LESS NOTICEABLE SMALLER PIN HEAD DIAMETER AND BUILT-IN SIDE SLOT FOR EASY REMOVAL.

<u>PART #</u>	<u>CTN QTY</u>	<u>STYLE</u>	<u>DESCRIPTION</u>	<u>WT PER/M</u>
120450	10,000	LOW PROFILE	.093 ENGAGED HEAD HEIGHT .240 PIN HEAD DIAMETER	1.2 Lbs
120451	10,000	STANDARD	.140 ENGAGED HEAD HEIGHT .430 PIN HEAD DIAMETER	1.4 Lbs

PERF SHELF DART CLIP

.250 HOLE SIZE X .001-.094 GRIP CAPACITY X .500 OVERALL LENGTH WITH .375 O.D.
ROUND HEAD POLYPROPYLENE - WHITE.



PACKAGING: BULK.

NOTES: FITS MOST ROUND, SQUARE OR DIAMOND SHAPED PERFORATED SHELF HOLES.
GRIPS MATERIAL UP TO 3/32" THICK. PROVIDES A SECURE HOLD. IS REMOVABLE WITH
A PINCH AND CAN BE REUSED.

<u>PART #</u>	<u>CTN QTY</u>	<u>DESCRIPTION</u>	<u>WT PER/M</u>
120400	25,000	.250 HOLE SIZE X .500 OVERALL LENGTH	0.4 Lbs

DIAMOND HOLE SHELF DART CLIP

.219 HOLE SIZE X .001-.093 GRIP CAPACITY X .420 SHANK LENGTH WITH .344 O.D.
ROUND HEAD. NYLON 6/6 - NATURAL.



PACKAGING: BULK.

NOTES: FITS DIAMOND SHAPED OR SQUARE PERFORATED SHELF HOLES. ALSO FITS 7/32" DIA.
ROUND HOLES. GRIPS MATERIAL UP TO 3/32" THICK. PROVIDES A SECURE HOLD. IS REMOVABLE
WITH A PINCH AND CAN BE REUSED. ALSO AVAILABLE IN **BLACK**.

<u>PART #</u>	<u>CTN QTY</u>	<u>DESCRIPTION</u>	<u>WT PER/M</u>
120430	10,000	.219 HOLE SIZE X .420 SHANK LENGTH	0.5 Lbs

PERF SHELF CHANNEL FASTENER

.250 HOLE SIZE X .078-.375 GRIP CAPACITY X .500 LONG WITH .625 O.D.
FLAT HEAD. NYLON 6/6 - WHITE.

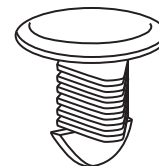

PACKAGING: BULK.

NOTES: UNIQUE TRIANGULAR FIN DESIGN THAT FITS MOST ROUND, SQUARE OR DIAMOND
SHAPED PERFORATED SHELF HOLES. IS REMOVABLE AND CAN BE RE-USED. GRIPS MATERIAL UP
TO 3/8" THICK. ALSO AVAILABLE IN **BLACK**.

<u>PART #</u>	<u>CTN QTY</u>	<u>DESCRIPTION</u>	<u>WT PER/M</u>
120407	10,000	.250 HOLE SIZE X .500 SHANK LENGTH	0.9 Lbs

PERF SHELF WHITE SNAP RIVET

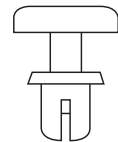

1/4" HOLE SIZE X .098-.157 GRIP RANGE X .240" SHANK LENGTH WITH .490" O.D. ROUND HEAD. PRE-ASSEMBLED TWO PIECE DESIGN. NYLON 6/6-NATURAL. ALSO AVAILABLE IN **BLACK**.

PACKAGING: BULK

NOTES: WHEN COMBINED WITH MOST ROUND PERFORATED SHELF HOLES RIVET YIELDS .060 GRIP CAPACITY. NOT RECOMMENDED FOR SQUARE OR DIAMOND PERF SHELF HOLES. SIMPLY PRESS DOWN HEAD TO EXPAND LEGS THAT LOCK PANELS AND COMPONENTS FIRMLY IN PLACE. NO TOOLS REQUIRED.

<u>PART #</u>	<u>CTN QTY</u>	<u>DESCRIPTION</u>	<u>WT PER/M</u>
120452	10,000	1/4" HOLE SIZE X .240" LONG	1.1 Lbs

DIAMOND HOLE SHELF PUSH-IN CLIP

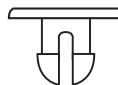

.219 HOLE SIZE X .001-.121 GRIP CAPACITY X .274 SHANK LENGTH WITH .469 O.D. ROUND HEAD. NYLON 6/6-NATURAL.

PACKAGING: BULK.

NOTES: FEATURES A LARGER HEAD THAN OUR COMMON SHELF DART CLIPS. FITS DIAMOND SHAPED OR SQUARE PERFORATED SHELF HOLES. ALSO FITS 7/32" DIA. ROUND HOLES. GRIPS MATERIALS UP TO .121 THICK. PROVIDES A SECURE HOLD. IS REMOVABLE WITH A PINCH AND CAN BE REUSED. ALSO AVAILABLE IN **BLACK**.

<u>PART #</u>	<u>CTN QTY</u>	<u>DESCRIPTION</u>	<u>WT PER/M</u>
120858	10,000	.219 HOLE SIZE X .274 SHANK LENGTH	0.6 Lbs

EXPAND-A-LOCK CONNECTOR



5/32" HOLE SIZE X .100-.250 GRIP CAPACITY X .315 SHANK LENGTH WITH 9/32" O.D. ROUND HEAD. PRE-ASSEMBLED TWO PIECE DESIGN. NYLON 6/6-NATURAL. ALSO AVAILABLE IN **BLACK**.

PACKAGING: BULK.

NOTES: PUSH-FIT RIVET STYLE EXPANSION FASTENER THAT REQUIRES NO TOOLS AND FITS MOST 5/32"-11/64" ROUND HOLES. SIMPLY PRESS PIN IN TO EXPAND LEGS THAT LOCK PANELS AND COMPONENTS FIRMLY IN PLACE.

<u>PART #</u>	<u>CTN QTY</u>	<u>DESCRIPTION</u>	<u>WT PER/M</u>
120405	10,000	5/32" HOLE SIZE X .315 LONG	0.4 Lbs

HEAVY DUTY EXPAND-A-LOCK

1/4" HOLE SIZE X .060-.228 GRIP CAPACITY X .562 SHANK LENGTH WITH 11/16" O.D. ROUND HEAD. PRE-ASSEMBLED TWO PIECE DESIGN. NYLON 6/6-**BLACK**.

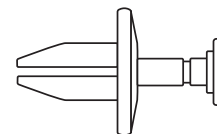

PACKAGING: BULK.

NOTES: SIMPLY PRESS PIN IN TO EXPAND TWO TAPERED LEGS THAT LOCK PANELS AND COMPONENTS FIRMLY IN PLACE. FITS STANDARD 1/4" PEGBOARD HOLES AND 1/4" ROUND SHAPED PERFORATED SHELF HOLES (NOT SQUARE OR DIAMOND). REMOVABLE AND REUSABLE.

<u>PART #</u>	<u>CTN QTY</u>	<u>DESCRIPTION</u>	<u>WT PER/M</u>
120399B	10,000	1/4" HOLE SIZE X 9/16" LONG	2.3 Lbs

DART CLIP-SMALL

.187 HOLE SIZE X .125-.187 GRIP CAPACITY X .563 LONG WITH .406 O.D. ROUND HEAD. NYLON 6/6-NATURAL

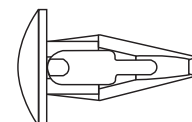

PACKAGING: BULK.

NOTES: FOR USE IN DRILLED, PUNCHED OR MOLDED HOLES WHERE FAST AND/OR BLIND INSTALLATION IS REQUIRED. HOLLOW BODY DESIGN ALLOWS THE CLIP TO COMPRESS WHEN PUSHED INTO HOLE THEN EXPAND BACK FOR A SECURE HOLD. REMOVABLE AND REUSABLE. ALSO AVAILABLE IN **BLACK**.

<u>PART #</u>	<u>CTN QTY</u>	<u>DESCRIPTION</u>	<u>WT PER/M</u>
120431	10,000	.187 HOLE SIZE X .563 SHANK LENGTH	0.6 Lbs

DART (ARROW) CLIP FASTENER

A VARIETY OF HOLE SIZES, LENGTHS AND HEAD DIAMETERS AVAILABLE WITH ROUND HEADS FOR USE IN DRILLED, PUNCHED OR MOLDED HOLES WHERE FAST AND/OR BLIND INSTALLATION IS REQUIRED - NYLON 6/6 NATURAL. (PART #120419 IS ACETAL).

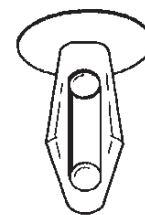

PACKAGING: BULK.

NOTES: HOLLOW BODY DESIGN ALLOWS THE CLIP TO COMPRESS WHEN PUSHED INTO HOLE THEN EXPAND BACK FOR A SECURE HOLD THAT RESISTS REMOVAL. LOW COST WAY TO ASSEMBLE THIN GAUGE MATERIALS. SIMPLY SNAP IN, NO TOOLS REQUIRED. REMOVABLE AND REUSABLE. ALSO AVAILABLE IN **BLACK**.

<u>PART #</u>	<u>CTN QTY</u>	<u>HOLE SIZE</u>	<u>SHANK LENGTH</u>	<u>GRIP CAPACITY</u>	<u>HEAD O.D.</u>	<u>HEAD HEIGHT</u>	<u>WT PER/M</u>
120410	10,000	.131-.135	.390	.062-.125	.280	.060	0.2 L bs
120411	10,000	.145-.150	.530	.290-.300	.270	.070	0.3 L bs
120412	10,000	.151-.161	.400	.062-.145	.280	.060	0.2 L bs
120413	10,000	.182-.192	.400	.062-.125	.360	.060	0.3 L bs
120414	10,000	.182-.192	.518	.165-.187	.370	.060	0.4 L bs
120415	10,000	.182-.192	.550	.310-.330	.370	.060	0.5 L bs
120416	10,000	.213-.223	.450	.062-.125	.370	.060	0.4 L bs
120417	10,000	.213-.223	.540	.125-.187	.370	.060	0.5 L bs
120418*†	10,000	.250-.260	.575	.125-.187	.484	.060	0.8 L bs
120419	5,000	.250-.260	.600	.165-.250	.562	.070	1.0 L bs
120420	5,000	.250-.260	.810	.360-.380	.610	.065	1.3 L bs

*VERY POPULAR FOR DISPLAY CONSTRUCTION AND 1/4" HOLE DIA. PEGBOARD USE.

† ALSO AVAILABLE IN CLEAR POLYCARBONATE.

DOUBLE END X-MAS TREE FASTENER

POPULAR X-MAS TREE STYLE LOCKING FINES ON EACH SIDE OF A CENTER FLANGE, NYLON 6/6 NATURAL. ALSO AVAILABLE IN **BLACK**.



PACKAGING: BULK.

NOTES: USED AS A CROSS MEMBER WHEN PRESSED INTO TOP AND/OR BOTTOM EDGES OF SIGNS THAT SLIDE INTO EXTRUDED FRAMES. ALSO USE TO ATTACH TWO SIGN PANELS BACK TO BACK.

<u>PART #</u>	<u>CTN QTY</u>	<u>INFO</u>	<u>HOLE SIZE</u>	<u>GRIP CAPACITY</u>	<u>SHANK LENGTH</u>	<u>OVERALL LENGTH</u>	<u>WT PER/M</u>
120204B	25,000	END #1)	.156	.105-.250	.305	.677	0.4 L bs
		END #2)	.156	.105-.250	.305		
120219	5,000	END #1)	.312	.125-.375	.455	1.35	2.4 L bs
		END #2)	.312	.140-.750	.855		

X-MAS TREE CLIP FASTENER

A VARIETY OF HOLE SIZES, LENGTHS, HEAD AND POINT STYLES AVAILABLE FOR USE IN DRILLED, PUNCHED OR MOLDED, THREADED OR NON-THREADED HOLES WHERE FAST AND/OR BLIND INSTALLATION IS REQUIRED - NYLON 6/6 NATURAL.

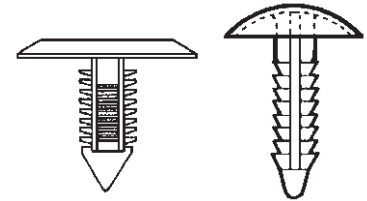

FIN TYPE "X"

FIN TYPE "R"

PACKAGING: BULK.

NOTES: FLEXIBLE RIBS DEFLECT WHEN PUSHED INTO HOLE THEN SPRING BACK FOR A SECURE LOCK THAT RESISTS REMOVAL. UNIVERSAL USE IN A WIDE VARIETY OF MATERIALS SUCH AS METAL, WOOD, FOAM, RUBBER AND PLASTIC, IN BOTH SOLID AND COMPRESSED FORMS. FOR USE IN A WIDE RANGE OF PANEL THICKNESSES. ALSO AVAILABLE IN **BLACK**.

<u>PART #</u>	<u>CTN QTY</u>	<u>HOLE SIZE</u>	<u>GRIP CAPACITY</u>	<u>SHANK LENGTH</u>	<u>FIN TYPE</u>	<u>HEAD O.D.</u>	<u>HEAD STYLE</u>	<u>WT PER/M</u>
120221	10,000	.125	.135-.250	.308	X	.240	FLAT	0.3 L bs
120232	18,000	.136	.030-.195	.375	R	.360	ROUND	0.3 L bs
120228	15,000	.156	.030-.234	.432	R	.360	ROUND	0.4 L bs
120207	10,000	.156	.035-.312	.531	X	.375	MOD.FLAT	0.7 L bs
120208	10,000	.187	.035-.210	.438	X	.437	FLAT	0.7 L bs
120220	10,000	.187	.030-.312	.480	R	.437	ROUND	0.7 L bs
120234	15,000	.187	.030-.312	.480	R	.734	ROUND	1.5 L bs
120211	10,000	.187	.080-.400	.560	X	.337	ROUND	0.6 L bs
120210	10,000	.187	.080-.402	.640	X	.437	FLAT	0.8 L bs
120214	25,000	.187	.030-.512	.680	R	.437	ROUND	0.9 L bs
120218	10,000	.187	.100-.600	.700	X	.470	GRAIN.BIND	0.7 L bs
120206	10,000	.203	.060-.480	.700	X	.750	GRAIN.FLAT	1.4 L bs
120233	10,000	.218	.060-.560	.774	R	.510	ROUND	1.3 L bs
120230	16,000	.218	.060-.560	.774	R	.650	ROUND	1.4 L bs
120212*	10,000	.234	.080-.312	.500	X	.609	FLAT	0.9 L bs
120209	10,000	.234	.140-.750	.945	X	.500	BINDER	1.2 L bs
120200*††	10,000	.250	.095-.320	.500	X	.750	FLAT	1.0 L bs
120226	14,000	.250	.090-.350	.610	R	.700	ROUND	1.3 L bs
120229	10,000	.250	.125-.406	.625	R	.500	BINDER	0.8 L bs
120205*†	12,000	.250	.098-.472	.802	R	.700	ROUND	1.5 L bs
120213	9,000	.250	.098-.800	1.060	R	.700	ROUND	1.8 L bs
120242	5,000	.250	.040-.750	1.065	X	.750	SQUARE	2.5 L bs
120201	4,000	.250	.065-1.25	1.440	X	1.000	FLAT	3.7 L bs
120216	5,000	.281	.050-.440	.703	X	.937	CROWNED	2.0 L bs
120203	10,000	.281	.093-.470	.745	X	.625	FLAT	1.4 L bs
120231	10,000	.281	.059-.555	.834	R	.748	ROUND	2.1 L bs
120217B	2,500	.281	.530-.920	1.190	X	1.250	BINDER	4.6 L bs
120225	6,000	.281	.060-1.00	1.200	R	.750	ROUND	2.9 L bs
120202	5,000	.281	.050-.900	1.260	X	.760	CROWNED	2.5 L bs
120215	5,000	.281	.100-.870	1.310	X	.600	CROWNED	2.4 L bs
120222	10,000	.312	.130-.500	.660	X	.500	BINDER	1.3 L bs
120227B	5,000	.343	.055-.510	.752	R	.630	BINDER	1.8 L bs
120223	5,000	.394	.060-.787	1.110	R	.846	ROUND	5.0 L bs
120224	5,500	.406	.115-.565	.820	R	1.000	ROUND	4.2 L bs

* VERY POPULAR FOR SHELVING AND DISPLAY CONSTRUCTION.

† ALSO AVAILABLE IN WHITE AND CLEAR.

†† ALSO AVAILABLE IN CLEAR.

MANUFACTURERS' PART # CROSS REFERENCE GUIDE

* NYLON 6/6 FASTENERS.

* SPECIAL COLORS / MATERIALS / DYES / PAINTED HEADS ALSO AVAILABLE, PLEASE INQUIRE.

* ALSO AVAILABLE IN **BLACK**.

<u>DESCRIPTION</u>	<u>OUR #</u>	<u>ITW FASTEX*</u>
X-MAS TREE CLIP	120200	354-250103-00
X-MAS TREE CLIP	120201	354-250303-00
X-MAS TREE CLIP	120202	354-280307-00
X-MAS TREE CLIP	120203	354-280308-00
X-MAS TREE CLIP	120204	354-162200-00
X-MAS TREE CLIP	120205	354-250311-00
X-MAS TREE CLIP	120205	M39-0630-10
X-MAS TREE CLIP	120206	354-200101-00
X-MAS TREE CLIP	120207	354-156001-00
X-MAS TREE CLIP	120208	354-120240-00
X-MAS TREE CLIP	120209	354-220000-00
X-MAS TREE CLIP	120210	354-190001-00
X-MAS TREE CLIP	120211	354-190001-01
X-MAS TREE CLIP	120215	354-280317-00
X-MAS TREE CLIP	120216	354-280301-00
X-MAS TREE CLIP	120217	354-280305-00
X-MAS TREE CLIP	120218	354-200102-00
X-MAS TREE CLIP	120219	354-201960-00
X-MAS TREE CLIP	120221	354-125300-00
X-MAS TREE CLIP	120222	354-310102-00
X-MAS TREE CLIP	120223	M39-1000-01
X-MAS TREE CLIP	120226	M39-0650-05
X-MAS TREE CLIP	120227	M39-0885-01
X-MAS TREE CLIP	120242	354-070201-00
RATCHET RIVET	120300	236-170406-00
RATCHET RIVET	120302	236-170406-02
RATCHET RIVET	120303	236-170406-03
RATCHET RIVET	120304	236-170406-04
RATCHET RIVET	120305	236-170406-05
RATCHET RIVET	120307	236-170406-07
RATCHET RIVET	120308	236-170406-08
RATCHET RIVET	120309	236-170406-09
SNAP RIVET -FEMALE	120320	236-220604-00
SNAP RIVET -MALE	120325	236-220603-00
SNAP RIVET -MALE	120327	236-220603-02
SNAP RIVET -MALE	120329	236-220603-10

*ITW FASTEX (ITW FASTEX IS A REGISTERED TRADEMARK OF THE FASTEX DIVISION OF THE ILLINOIS TOOL WORKS COMPANY).

K INTERNATIONAL 6/6 NYLON X-MAS TREE CLIP, RATCHET RIVET, AND SNAP RIVET FASTENERS ARE NOT MANUFACTURED BY OR CONNECTED WITH THE PRODUCERS OF ITW FASTEX FASTENERS.

CHANNEL MOUNT ARROW FASTENERS

TWO LENGTHS TO CHOOSE FROM BOTH WITH BASES MEASURING .500" WIDE X 1.20" LONG (WITH OR WITHOUT ADHESIVE). BASE WITHOUT ADHESIVE SECURELY SNAPS INTO STANDARD 1-1/4" SHELF PRICE CHANNELS. BASE WITH ADHESIVE ADDS EXTRA STRENGTH WHEN PRESSED INTO SHELF PRICE CHANNELS OR CAN BE USED ON ANY CLEAN, FLAT SURFACE. REQUIRED HOLE SIZE IS 1/4" - 9/32" DIAMETER. NATURAL POLYPROPYLENE MATERIAL.

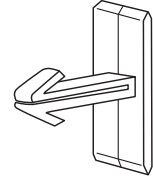

PACKAGING: BAGGED AS SHOWN BELOW.

NOTES: FLEXIBLE ARROW TIP DEFLECTS WHEN PUSHED INTO HOLE THEN SPRINGS BACK AS A CLIP THAT RESISTS REMOVAL. IDEAL FOR TAKE-ONE PROMOTIONS. INEXPENSIVE WAY TO DISPLAY COUPON PADS, BOOKS OR SIGNS FROM SHELF PRICE CHANNELS OR CLEAN, FLAT SURFACES.

<u>PART #</u>	<u>CTN QTY</u>	<u>BAG QTY</u>	<u>STEM LENGTH</u>	<u>PAD THICKNESS</u>	<u>STYLE</u>	<u>WT PER/M</u>
120456	10,000	250	1/2"	UP TO 7/16"	NO ADHESIVE	2.0 Lbs
120457	10,000	250	1/2"	UP TO 7/16"	WITH ADHESIVE	2.3 Lbs
120458	5,000	100	15/16"	UP TO 7/8"	NO ADHESIVE	2.4 Lbs
120459	5,000	100	15/16"	UP TO 7/8"	WITH ADHESIVE	2.7 Lbs

EASY-FLEX CHANNEL MOUNT ARROW FASTENER

OUR MOST POPULAR ARROW FASTENER DESIGNED FOR EVEN EASIER INSERTION INTO STANDARD 1-1/4" SHELF PRICE CHANNELS. BASE MEASURES .437" WIDE X 1.20" LONG WITHOUT ADHESIVE. REQUIRED HOLE SIZE IS 1/4" - 9/32" DIAMETER. HOLDS PADS UP TO 7/16" THICK. NATURAL POLYPROPYLENE MATERIAL.

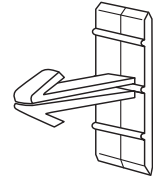

PACKAGING: BAGGED 250 PCS PER.

NOTES: INEXPENSIVE WAY TO DISPLAY COUPON PADS, BOOKS OR SIGNS FROM SHELF PRICE CHANNELS. IDEAL FOR TAKE-ONE PROMOTIONS. FLEXIBLE ARROW TIP DEFLECTS WHEN PUSHED INTO HOLE THEN SPRINGS BACK AS A CLIP THAT RESISTS REMOVAL.

<u>PART #</u>	<u>CTN QTY</u>	<u>DESCRIPTION</u>	<u>WT PER/M</u>
120455	10,000	1/2" STEM LENGTH	1.5 Lbs

SELF-PIERCING FLAG SIGN HOLDER

3" OVERALL LENGTH WITH 3/4" FOLD SECTION. CLIP HOOKS INTO MOST STANDARD PERFORATED SHELVES AND SECURELY HOLDS PAPER SIGNS UP TO .015" THICK IN FLAG POSITION. NATURAL POLY PROPYLENE MATERIAL.

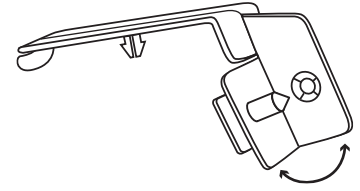

PACKAGING: BAGGED 100 PCS PER.

NOTES: VERY POPULAR, REUSEABLE PERF SHELF CLIP FEATURING A PIERCING MALE PIN THAT EASILY FOLDS AND PUNCTURES PAPER SIGNS FOR A SECURE HOLD. A SNAPPING MALE MECHANISM ENSURES THAT THE SIGN WILL BE HELD FIRMLY IN PLACE.

<u>PART #</u>	<u>CTN QTY</u>	<u>DESCRIPTION</u>	<u>WT PER/M</u>
107200	1,000	3" OVERALL LENGTH	4.4 Lbs

SELF-PIERCING CHANNEL FLAG HOLDER

1" WIDE X 1-1/4" HEIGHT WITH 7/8" FOLD SECTION. FITS STANDARD 1-1/4" SHELF PRICE CHANNELS. SECURELY HOLDS PAPER SIGNS UP TO .015" THICK IN FLAG POSITION. NATURAL POLYPROPYLENE.

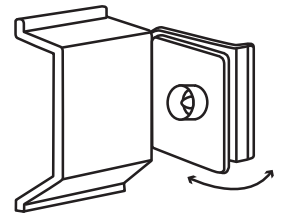

PACKAGING: BAGGED 500 PCS PER.

NOTES: VERY POPULAR, REUSEABLE SHELF PRICE CHANNEL CLIP FEATURING A PIERCING MALE PIN THAT EASILY FOLDS AND PUNCTURES PAPER SIGNS FOR A SECURE HOLD. GREAT FOR EVER-CHANGING SALE SIGNS. HOLDS SIGNS PERPENDICULAR TO SHELF.

<u>PART #</u>	<u>CTN QTY</u>	<u>DESCRIPTION</u>	<u>WT PER/M</u>
107201	5,000	FITS 1-1/4" PRICE CHANNEL/RAIL	4.3 Lbs

SELF-PIERCING CHANNEL FLUSH HOLDER

1-1/8" WIDE X 1-3/4" OVERALL HEIGHT WITH 1-1/4" FOLDED HEIGHT. FITS STANDARD 1-1/4" SHELF PRICE CHANNELS. SECURELY HOLDS PAPER SIGNS UP TO .015" THICK IN FLUSH POSITION. NATURAL POLYPROPYLENE.

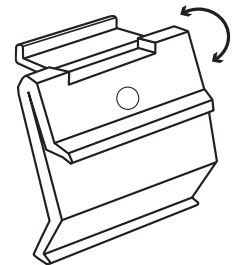

PACKAGING: BAGGED 500 PCS PER.

NOTES: VERY POPULAR, REUSEABLE SHELF PRICE CHANNEL CLIP FEATURING A PIERCING MALE PIN THAT EASILY FOLDS AND PUNCTURES PAPER SIGNS FOR A SECURE HOLD. GREAT FOR EVER-CHANGING SALE SIGNS.

<u>PART #</u>	<u>CTN QTY</u>	<u>DESCRIPTION</u>	<u>WT PER/M</u>
107202	4,000	FITS 1-1/4" PRICE CHANNEL/RAIL	4.2 Lbs

PRICE CHANNEL SIGN HOLDER

SNAPS SECURELY TO FIT ALL STANDARD 1-1/4" SHELF PRICE CHANNELS. HOLDS MATERIAL UP TO .060" THICK. MEASURES 1-1/2" LONG X 1" WIDE X 3/4" HEIGHT. NATURAL TRANSLUCENT POLYPROPYLENE.

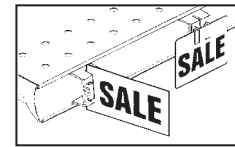
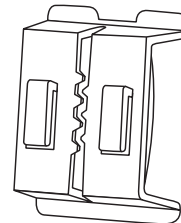

PACKAGING: BAGGED 50 PER.

NOTES: OUR MOST ECONOMICAL SHELF EDGE CLIP. EXTREMELY VERSATILE CLIP THAT SECURELY HOLDS ALL TYPES OF SIGNS IN THREE WAYS: FLUSH (UP & DOWN) OR FLAG POSITION.

<u>PART #</u>	<u>CTN QTY</u>	<u>DESCRIPTION</u>	<u>WT PER/M</u>
107125	5,000	FITS 1-1/4" PRICE CHANNEL/RAIL	4.3 Lbs

GRIPPER TWIST-IN SIGN HOLDER

1-1/4" LG (1.15" CUT LENGTH) X 5/8" OVERALL HEIGHT WITH 1/2" BASE WIDTH. FITS STANDARD 1-1/4" SHELF PRICE CHANNELS WITH A SIMPLE TWIST-IN. HOLDS SIGNS UP TO .080" THICK. CLEAR PVC MATERIAL.

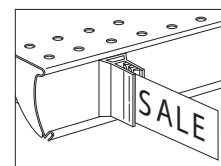
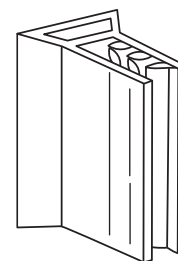

PACKAGING: BULK.

NOTES: JUST INSERT BASE OF CLIP INTO STANDARD 1-1/4" SHELF PRICE CHANNEL AND TWIST-IN FOR SECURE LOCKING ACTION. GRIPPER FINS HOLD SIGN FIRM IN FLAG (VERTICAL) POSITION. PART IS REMOVABLE AND REUSABLE.

<u>PART #</u>	<u>CTN QTY</u>	<u>DESCRIPTION</u>	<u>WT PER/M</u>
108549	5,000	1-1/4" PRICE CHANNEL USE	5.1 Lbs

CHANNEL MOUNT WITH ADHESIVE

SNAPS SECURELY TO FIT ALL STANDARD 1-1/4" SHELF PRICE CHANNELS. 2" LONG X 1-1/4" HEIGHT WITH 1" HEIGHT ADHESIVE. EXTENDS OUTWARD APPROXIMATELY 1/2" FROM SHELF. ALSO AVAILABLE IN CUSTOM LENGTHS. CLEAR PVC.

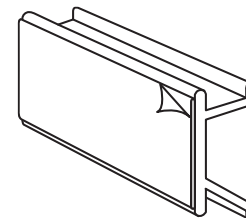

PACKAGING: BULK.

NOTES: SECURELY MOUNTS A VARIETY OF SIGNS, COUPON BOOKS/BOXES OR LIGHTWEIGHT DISPLAYS TO SHELF PRICE CHANNELS. ALSO KNOWN AS ADVERTISER RAIL CLIPS.

<u>PART #</u>	<u>CTN QTY</u>	<u>DESCRIPTION</u>	<u>WT PER/M</u>
107124	2,500	FITS 1-1/4" PRICE CHANNEL/RAIL	13.4 Lbs

CHANNEL MOUNT SPRING WOBBLER

1" LONG X 11/32" O.D. METAL SPRING CENTER WITH 3/4" SQUARE ADHESIVE BACKED MOUNT ONE END AND SHELF PRICE CHANNEL MOUNT ON OTHER END - WHITE POLYPROPYLENE.

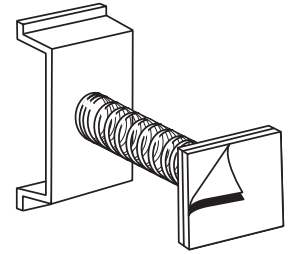

PACKAGING: BAGGED 100 PER.

NOTES: ONE END SNAPS SECURELY TO FIT MOST STANDARD 1-1/4" SHELF CHANNELS, OTHER END ADHERES TO SIGNS OR PROMOTIONAL ITEMS. LIGHTWEIGHT, LIVELY METAL SPRING CREATES ATTENTION GRABBING ACTION.

<u>PART #</u>	<u>CTN QTY</u>	<u>DESCRIPTION</u>	<u>WT PER/M</u>
107131	2,500	1" SPRING LENGTH X 3/4" WIDE MOUNT	6.2 Lbs

SPRING WOBBLER

1" LONG X 11/32" O.D. METAL SPRING CENTER WITH 3/4" SQUARE ADHESIVE BACKED MOUNTING ENDS - WHITE POLYPROPYLENE.

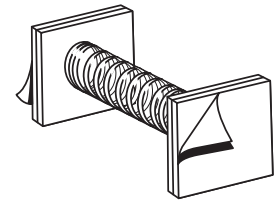

PACKAGING: BAGGED 100 PER.

NOTES: COST EFFECTIVE WAY TO ADD MOTION TO ANY SIGN, DISPLAY OR PROMOTIONAL ITEM. LIGHTWEIGHT, LIVELY METAL SPRING CREATES ATTENTION GRABBING ACTION. MOUNTING ENDS ADHERE TO ANY FLAT/CLEAN SURFACE.

<u>PART #</u>	<u>CTN QTY</u>	<u>DESCRIPTION</u>	<u>WT PER/M</u>
107130	2,500	1" SPRING LENGTH X 3/4" WIDE MOUNTS	4.8 Lbs

CLEAR POWER WIRE WING CLIP

FITS UP TO .250 DIA. WIRE AND 1/8"-1/4" (A & B FLUTE) CORRUGATED. CLEAR RIGID PVC MATERIAL.

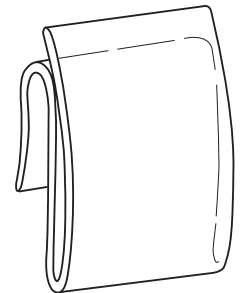

PACKAGING: BULK.

NOTES: BOTH CLIP WIDTHS ARE POPULAR FOR HEAVY APPLICATIONS WITH PART #107104 OFFERING EXTRA DUTY STRENGTH. DESIGNED TO SECURELY ATTACH CORRUGATED DISPLAYS ON WIRE POWER WING/BAR (I.E. SIDE KICK). ADDITIONAL WIDTHS AND COLORS CAN BE MADE TO ORDER.

<u>PART #</u>	<u>CTN QTY</u>	<u>DESCRIPTION</u>	<u>WT PER/M</u>
107103	1,600	1" WIDE X 2" LONG	21.0 Lbs
107104	1,100	1-1/2" WIDE X 2" LONG	31.5 Lbs

POWER WIRE WING CLIP

FITS UP TO .250" DIA. WIRE AND 1/8" THICK CORRUGATED. WHITE SUPER TOUGH NYLON MATERIAL.

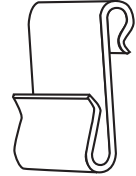

PACKAGING: BULK.

NOTES: OUR MOST POPULAR SIZE. SECURELY ATTACH CORRUGATED DISPLAYS ON WIRE POWER WING/BAR (I.E. SIDE KICK). ADDITIONAL WIDTHS AND COLORS CAN BE MADE TO ORDER.

<u>PART #</u>	<u>CTN QTY</u>	<u>DESCRIPTION</u>	<u>WT PER/M</u>
107101	1,000	1" WIDE X 1-3/4" LONG	11.9 Lbs

POWER WIRE WING CLIP

FITS UP TO .250" DIA. WIRE AND 1/8" THICK CORRUGATED. WHITE PVC MATERIAL.

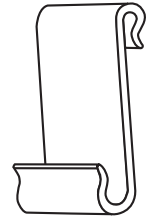

PACKAGING: BULK.

NOTES: DESIGNED TO SECURELY ATTACH CORRUGATED DISPLAYS ON WIRE POWER WING/BAR (I.E. SIDE KICK). ADDITIONAL WIDTHS AND COLORS CAN BE MADE TO ORDER.

<u>PART #</u>	<u>CTN QTY</u>	<u>DESCRIPTION</u>	<u>WT PER/M</u>
107100	2,000	1" WIDE X 2" LONG	10.3 Lbs

HEAVY DUTY POWER WIRE WING CLIP

FITS UP TO .250" DIA. WIRE AND 1/8" THICK CORRUGATED. WHITE POLYPROPYLENE MATERIAL.

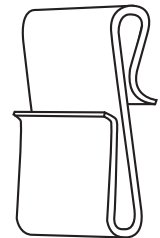

PACKAGING: BAGGED 100 PER.

NOTES: LARGER CLIP WIDTH ADDS EXTRA STRENGTH. DESIGNED TO SECURELY ATTACH CORRUGATED DISPLAYS ON WIRE POWER WING/BAR (I.E. SIDE KICK). ADDITIONAL WIDTHS AND COLORS CAN BE MADE TO ORDER.

<u>PART #</u>	<u>CTN QTY</u>	<u>DESCRIPTION</u>	<u>WT PER/M</u>
107102	2,000	1-1/4" WIDE X 2-1/4" LONG	13.9 Lbs

PEGBOARD / SLATWALL POWER WING CLIP

1-1/4" WIDE X 1-1/4" LONG WITH 1" ON CENTER PRONGS THAT FIT STANDARD 1/4" DIAMETER PEGBOARD AND SLATWALL. HOLDS UP TO 1/4" A-FLUTE CORRUGATED. WHITE POLYPROPYLENE MATERIAL.

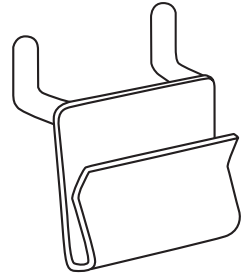

PACKAGING: BAGGED 100 PER.

NOTES: DESIGNED TO SECURELY ATTACH CORRUGATED DISPLAYS IN FLUSH POSITION TO PEGBOARD AND SLATWALL. PRONGS MOUNT TO PEGBOARD WITH HOLES 1" ON CENTER.

<u>PART #</u>	<u>CTN QTY</u>	<u>DESCRIPTION</u>	<u>WT PER/M</u>
107105	2,500	1-1/4" WIDE X 1-1/4" LONG	10.2 Lbs

PEGBOARD / SLATWALL ADAPTERS

TWO SIZES TO CHOOSE FROM: A STANDARD TWO PRONG MEASURING 2-3/8" LONG WITH 5/8" HEIGHT MOUNTING BASE MADE OF HIGH IMPACT WHITE OR CLEAR PLASTIC AND A FOUR PRONG HEAVY DUTY MEASURING 3-1/2" LONG WITH 1" HEIGHT MOUNTING BASE MADE OF NATURAL POLYPROPYLENE. BOTH FIT STANDARD 1/4" PEGBOARD HOLES OR SLATWALL AND ARE ADHESIVE BACKED. *PART #108510C IS ALSO AVAILABLE WITHOUT ADHESIVE.

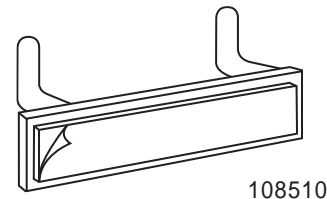

108510

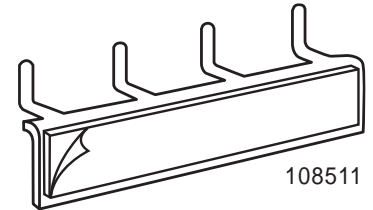

108511

PACKAGING: BAGGED AS SHOWN BELOW.

NOTES: FLUSH MOUNT CONNECTORS THAT SIMPLY HOOK INTO PEGBOARD HOLES OR SLATWALL. USE TO ATTACH SIGNS, POCKETS OR LITERATURE HOLDERS.

<u>PART #</u>	<u>CTN QTY</u>	<u>BAG QTY</u>	<u>DESCRIPTION</u>	<u>WT PER/M</u>
108510	1,000	100	2-3/8" LG, HOOKS 2" ON CTR-WHITE WITH ADHESIVE	8.7 Lbs
108510C	1,000	100	2-3/8" LG, HOOKS 2" ON CTR-CLEAR WITH ADHESIVE	8.7 Lbs
108509*	1,000	100	2-3/8" LG, HOOKS 2" ON CTR-CLEAR, NO ADHESIVE	8.5 Lbs
108511	1,000	50	3-1/2" LG, HOOKS 1" ON CTR-NATURAL WITH ADHESIVE	21.3 Lbs

SLATWALL ADAPTER WITH ADHESIVE

1", 2" AND 4" LENGTHS TO CHOOSE FROM - ALL WITH A PERMANENT ADHESIVE STRIP. MADE OF .063 THICK WHITE STYRENE MATERIAL. FITS ALL STANDARD SLATWALL GROOVES.

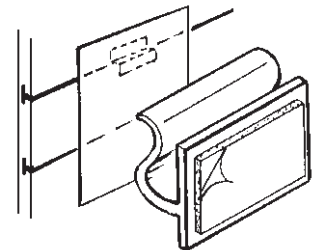

PACKAGING: BULK.

NOTES: USE TO ATTACH SIGNS, POCKETS, LITERATURE HOLDERS AND LIGHT WEIGHT DISPLAYS FLUSH AGAINST SLATWALL. HOLD DISPLAYS WITH ATTACHED PERMANENT ADHESIVE. ADDITIONAL LENGTHS CAN BE MADE TO ORDER.

<u>PART #</u>	<u>CTN QTY</u>	<u>DESCRIPTION</u>	<u>WT PER/M</u>
108500	4,500	1" OVERALL LENGTH	4.8 Lbs
108502	2,000	2" OVERALL LENGTH	9.6 Lbs
108504	1,000	4" OVERALL LENGTH	19.2 Lbs

Z-BAR SLATWALL ADAPTER

FLUSH-MOUNT CONNECTOR FOR SLATWALL MEASURING 2-3/8" OVERALL LENGTH THAT WHEN INSERTED INTO SLATWALL YIELDS A 3/4" HEIGHT ADHESIVE BACKED MOUNTING BASE. FITS ALL STANDARD SLATWALL GROOVES, CLEAR PVC MATERIAL.

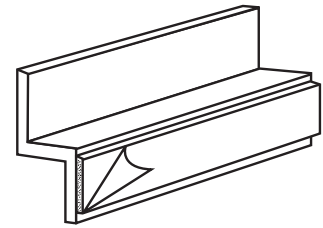

PACKAGING: BULK.

NOTES: USE TO ATTACH SIGNS, POCKETS OR LITERATURE HOLDERS FLUSH AGAINST SLATWALL. Z-BAR SHAPE IS WIDER AND STRONGER THAN OUR STANDARD SLATWALL ADAPTER. ALSO AVAILABLE IN CUSTOM LENGTHS AND ADDITIONAL COLORS.

<u>PART #</u>	<u>CTN QTY</u>	<u>DESCRIPTION</u>	<u>WT PER/M</u>
108512	1,000	2-3/8" OVERALL LENGTH	9.3 Lbs

SHELF SUPPORT CLIPS

TWO PIECE DESIGN (MALE & FEMALE) AVAILABLE IN TWO DIFFERENT SIZES THAT FIT UP TO 3/16" C-FLUTE CORRUGATED. MALE PARTS HAVE HOLES FOR GLUE SEEP THROUGH AND FEMALE PARTS HAVE SNAP-LOCK FEATURES. WHITE POLYPROPYLENE MATERIAL.

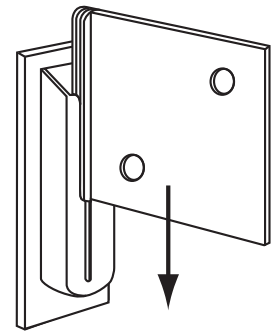

PACKAGING: BAGGED 100 PER.

NOTES: MAKES CORRUGATED ASSEMBLY EASY AND SAVES ON SHIPPING COSTS. PRIOR TO SHIPPING CORRUGATED DISPLAYS, TWO PIECE SHELF SUPPORT CLIPS ALLOW FOR PRE-ATTACHMENT OF "KNOCK-DOWN" SECTIONS. MALE AND FEMALE PARTS SOLD SEPARATELY.

<u>PART #</u>	<u>CTN QTY</u>	<u>DESCRIPTION</u>	<u>WT PER/M</u>
107140	3,000	SMALL MALE, 1-7/8"H X 2-1/4"L	12.1 Lbs
107141	3,000	SMALL FEMALE, 1-7/8"H	8.9 Lbs
107142	2,000	LARGE MALE, 2-3/8"H X 2-1/4"L	16.8 Lbs
107143	2,000	LARGE FEMALE, 2-3/8"H	10.0 Lbs

CLIP-ON CORRUGATED SHELF SUPPORTS

TWO STYLES TO CHOOSE FROM – BOTH FIT UP TO 1/8" B-FLUTE CORRUGATED. THE VERTICAL STYLE IS 2-1/4" LONG AND HAS SIDE HOLES FOR GLUE SEEP THROUGH. THE HORIZONTAL STYLE IS 2" LONG AND HAS TAPERED TEETH THAT BITE INTO CORRUGATED. NATURAL POLYPROPYLENE MATERIAL.

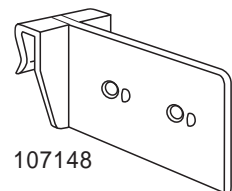

107148

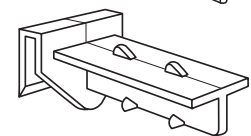

107149

PACKAGING: BAGGED 50 PER.

NOTES: USE TO SECURELY SUPPORT CORRUGATED SHELVES WITHIN DISPLAYS. THE VERTICAL STYLE IS FOR LIGHT TO MEDIUM WEIGHT APPLICATIONS AND THE HORIZONTAL STYLE IS FOR HEAVIER APPLICATIONS.

<u>PART #</u>	<u>CTN QTY</u>	<u>DESCRIPTION</u>	<u>WT PER/M</u>
107148	2,500	VERTICAL-STANDARD STRENGTH	14.0 Lbs
107149	2,500	HORIZONTAL-HEAVY DUTY STRENGTH	11.8 Lbs

PALLET DISPLAY CLIP

2" WIDE X 2" LONG X 7/16" DEPTH. ACCEPTS MATERIAL UP TO 3/8" THICK. CLEAR PVC MATERIAL. CUSTOM LENGTHS AVAILABLE.

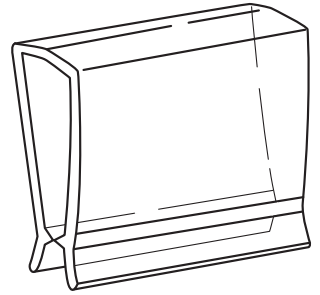

PACKAGING: BULK.

NOTES: IDEAL FOR SECURELY JOINING CORRUGATED PALLET DROP BINS AND BULK MERCHANDISING DISPLAYS TOGETHER - NO ADHESIVE REQUIRED. HEAVY DUTY GRIP CONNECTS PANEL EDGES OR FITS 2" WIDE SLOTS IN CORRUGATED DISPLAY PANELS.

<u>PART #</u>	<u>CTN QTY</u>	<u>DESCRIPTION</u>	<u>WT PER/M</u>
107120	1,000	2" WIDE X 2" LONG	32.4 Lbs

ADHESIVE WIRE / PEN CLIP

1/2" X 1/2" SQUARE BASE WITH ADHESIVE BACKING AND 7/16" OVERALL HEIGHT. FITS UP TO .313" DIAMETER WIRE, PENS OR PENCILS. WHITE POLYPROPYLENE MATERIAL.



PACKAGING: BAGGED 250 PCS PER.

NOTES: SNAP OVER WIRE TO ATTACH SIGNS WITH ADHESIVE OR USE TO HOLD PENS/PENCILS TO ANY CLEAN, FLAT SURFACE. SIMPLY PEEL AND STICK FOR A SECURE HOLD.

<u>PART #</u>	<u>CTN QTY</u>	<u>DESCRIPTION</u>	<u>WT PER/M</u>
108501	10,000	1/2" SQUARE BASE-WHITE	1.1 Lbs

ALL PURPOSE ADHESIVE CLIP

TWO SIZES TO CHOOSE FROM, BOTH HAVING 1" WIDTH AND ADHESIVE BACKING. THE .180 I.D. ACCEPTS UP TO .125" THICK MATERIAL OR CLIPS OVER MAXIMUM .180" DIAMETER WIRE. THE .300 I.D. ACCEPTS UP TO .187" THICK MATERIAL OR CLIPS OVER MAXIMUM .300" DIAMETER WIRE. WHITE STYRENE.

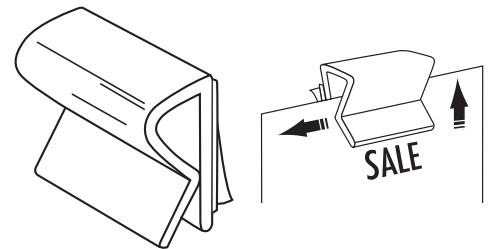

PACKAGING: BULK.

NOTES: SIGN MATERIALS EASILY SLIDE INTO CLIPS FOR FIRM GRIP. ADHERES TO ANY FLAT SURFACE OR CAN BE SNAPPED OVER WIRE WITH ADHESIVE SIDE USED TO HOLD SIGNS, LIGHTWEIGHT DISPLAYS OR LITERATURE HOLDERS.

<u>PART #</u>	<u>CTN QTY</u>	<u>DESCRIPTION</u>	<u>WT PER/M</u>
108506	5,000	.180 I.D. X .844" LONG	3.2 Lbs
108505	4,000	.300 I.D. X 1.00" LONG	7.3 Lbs

"J" HOOK WIRE SIGN HOLDER

1" WIDE X 3/4" FACE HEIGHT "J" STYLE WITH 3/4" WIDE ADHESIVE BACKING TO FIT UP TO 5/16" DIAMETER WIRE. WHITE STYRENE MATERIAL. CUSTOM LENGTHS AND COLORS AVAILABLE.

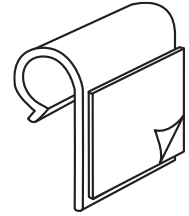

PACKAGING: BULK.

NOTES: ADHERES TO ANY FLAT SURFACE OR CAN BE HOOKED OVER WIRE WITH ADHESIVE SIDE USED TO HOLD SIGNS, LIGHTWEIGHT DISPLAYS OR LITERATURE HOLDERS. ALSO CAN BE USED WITH CORRUGATED DISPLAYS.

<u>PART #</u>	<u>CTN QTY</u>	<u>DESCRIPTION</u>	<u>WT PER/M</u>
108562	4,000	1" OVERALL WIDTH	4.5 Lbs

TIP-ON FLUSH SIGN HOLDER

1", 3", 6" AND 48" LONG X 7/8" HEIGHT WITH ADHESIVE BACKING. UNIVERSAL DESIGN FIRMLY GRIPS UP TO .050" THICK MATERIAL. ALSO AVAILABLE IN CUSTOM LENGTHS. SUPER CLEAR PETG MATERIAL.

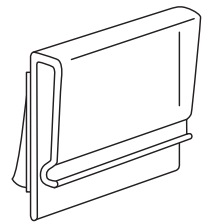

PACKAGING: BULK.

NOTES: SIGN MATERIALS SLIDE INTO CLIP FOR FIRM BENT TIP HOLD IN FLUSH POSITION. ADHERES TO ANY FLAT, CLEAN SURFACE AND IS USED TO HOLD SIGNS, LIGHTWEIGHT DISPLAYS OR LITERATURE HOLDERS.

<u>PART #</u>	<u>CTN QTY</u>	<u>DESCRIPTION</u>	<u>WT PER/M</u>
108566	5,000	1" OVERALL LENGTH	2.8 Lbs
108567	2,500	3" OVERALL LENGTH	8.3 Lbs
108568	1,000	6" OVERALL LENGTH	16.6 Lbs
108569	250	48" OVERALL LENGTH	132.8 Lbs

ROTATABLE GRIPPER SIGN HOLDER

6" LONG X 1" HEIGHT WITH BASE WIDTH OF 1-1/16" WITH ADHESIVE. HOLDS SIGNS UP TO .080" THICK. MAXIMUM 80 DEGREE, TWO-PIECE ROTATING DESIGN FOR DESIRED VIEWING ANGLE. ALSO AVAILABLE IN CUSTOM LENGTHS. WHITE PVC MATERIAL.

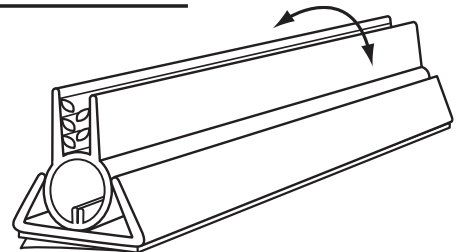

PACKAGING: BULK.

NOTES: GRIPPER FINS HOLD SIGN FIRM IN EITHER FLAG (VERTICAL) OR HORIZONTAL POSITION. ADHESIVE BOTTOM ADHERES TO ANY CLEAN, FLAT SURFACE.

<u>PART #</u>	<u>CTN QTY</u>	<u>DESCRIPTION</u>	<u>WT PER/M</u>
108536	250	6" OVERALL LENGTH	89.1 Lbs

GRIPPER WIRE FLAG SIGN HOLDER

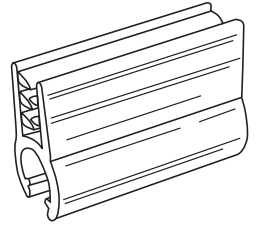

1" LONG X 11/16" HEIGHT TO FIRMLY FIT A .200 DIAMETER WIRE. HOLDS SIGNS UP TO .080" THICK. CLEAR PVC MATERIAL. CUSTOM LENGTHS AVAILABLE.

PACKAGING: BULK.

NOTES: CLIP-ON DESIGN, COUPLED WITH GRIPPER RIBS, FIRMLY ATTACH TO WIRE TO PREVENT SIGN FROM ROTATING ON WIRE THUS ALLOWING FOR A VARIETY OF VIEWING ANGLES. GREAT FOR USE ON WIRE FIXTURES, BASKETS OR EDGING.

<u>PART #</u>	<u>CTN QTY</u>	<u>DESCRIPTION</u>	<u>WT PER/M</u>
108521	5,000	1" OVERALL LENGTH	5.1 Lbs

GRIPPER WIRE FLUSH SIGN HOLDER

1/2" AND 1" LONG X 7/8" HEIGHT TO FIT WIRE DIAMETERS UP TO .375". HOLDS SIGNS UP TO .080" THICK. CLEAR PVC MATERIAL. CUSTOM LENGTHS AVAILABLE.



PACKAGING: BULK.

NOTES: GRIPPER FINS HOLD SECURELY FOR HANGING OF SIGNS IN FLUSH POSITION FROM WIRE FIXTURES, BASKETS, EDGING, ETC. CLIPS EASILY OVER WIRE. USE TWO OR MORE PIECES FOR LARGER SIGNS.

<u>PART #</u>	<u>CTN QTY</u>	<u>DESCRIPTION</u>	<u>WT PER/M</u>
108522	5,000	1/2" OVERALL LENGTH	3.0 Lbs
108529	2,500	1" OVERALL LENGTH	6.0 Lbs

GRIPPER FLUSH SIGN HOLDER

1", 1-1/2" AND 3" LONG X 3/4" HEIGHT "J" STYLE WITH ADHESIVE BACKING. HOLDS SIGNS UP TO .080 THICK. CLEAR PVC MATERIAL. ALSO AVAILABLE IN CUSTOM LENGTHS OR WITH A MAGNETIC BACKING.

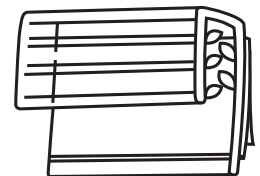

PACKAGING: BULK.

NOTES: GRIPPER FINS HOLD SIGN SECURELY IN FLUSH POSITION. ALSO CAN BE SNAPPED OVER .080 DIAMETER WIRE WITH ADHESIVE SIDE USED TO HOLD SIGNS, LIGHTWEIGHT DISPLAYS OR LITERATURE HOLDERS. ADHESIVE BACKING ADHERES TO ANY FLAT SURFACE.

<u>PART #</u>	<u>CTN QTY</u>	<u>DESCRIPTION</u>	<u>WT PER/M</u>
108515	5,000	1" OVERALL LENGTH	5.0 Lbs
108516	2,500	1-1/2" OVERALL LENGTH	7.5 Lbs
108517	1,000	3" OVERALL LENGTH	15.1 Lbs

GRIPPER "H" SIGN HOLDER

1" AND 3" LONG X 3/4" OVERALL HEIGHT. EACH SIDE FITS UP TO .080 THICK SIGNS OR UP TO .080 DIAMETER WIRE. CLEAR PVC MATERIAL. CUSTOM LENGTHS AVAILABLE.

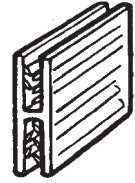

PACKAGING: BULK.

NOTES: GRIPPER FINS HOLD SECURELY FOR MOUNTING OF SIGNS ABOVE DISPLAYS, OTHER SIGNS OR TO WIRE FIXTURES. CAN BE USED IN EITHER FLAG (VERTICAL) OR HORIZONTAL POSITION. USE TWO OR MORE PIECES FOR LARGER SIGNS.

<u>PART #</u>	<u>CTN QTY</u>	<u>DESCRIPTION</u>	<u>WT PER/M</u>
108518	2,500	1" OVERALL LENGTH	5.8 L bs
108519	1,000	3" OVERALL LENGTH	17.5 L bs

GRIPPER SIGN HOLDER

1", 3" AND 6" LONG X 1/2" HEIGHT WITH BASE WIDTH OF EITHER 1/2" (NARROW) OR 1" (WIDE) WITH ADHESIVE. HOLDS SIGNS UP TO .080" THICK. CLEAR PVC MATERIAL. ALSO AVAILABLE IN CUSTOM LENGTHS OR WITHOUT ADHESIVE.

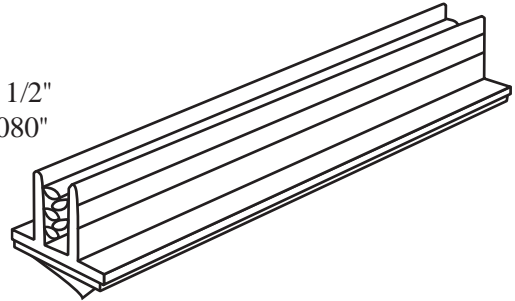

PACKAGING: BULK.

NOTES: GRIPPER FINS HOLD SIGN SECURELY IN FLAG (VERTICAL) OR HORIZONTAL POSITION. ADHESIVE BOTTOM ADHERES TO CLEAN, FLAT SURFACES. USE 1" WIDE BASE FOR MORE STABILITY.

<u>PART #</u>	<u>CTN QTY</u>	<u>DESCRIPTION</u>	<u>WT PER/M</u>
108523	2,500	1" OAL WITH 1/2" (NARROW) BASE	4.3 L bs
108525	2,000	1" OAL WITH 1" (WIDE) BASE	7.4 L bs
108524	1,000	3" OAL WITH 1/2" (NARROW) BASE	12.9 L bs
108526	500	3" OAL WITH 1" (WIDE) BASE	22.3 L bs
108535	250	6" OAL WITH 1" (WIDE) BASE	44.6 L bs

HINGED GRIPPER SIGN HOLDERS

TWO SIGN GRIP RANGES TO CHOOSE FROM: "STANDARD" AND "HEAVY DUTY". BOTH ARE AVAILABLE IN 3" AND 36" LENGTHS. "STANDARD" IS 3/4" HEIGHT WITH 1" WIDE BASE, "HEAVY DUTY" IS 7/8" HEIGHT WITH 1-1/8" WIDE BASE. ALL HAVE ADHESIVE BACKING. CLEAR PVC MATERIAL.

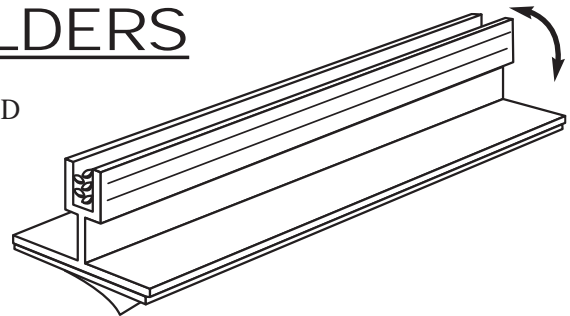

PACKAGING: BULK.

NOTES: GREAT FOR MOUNTING SIGNS IN HIGH TRAFFIC AREAS. FLEXIBLE HINGE SWINGS AND RETURNS TO ORIGINAL POSITION WHEN BUMPED. GRIPPER FINS HOLD SIGN FIRM IN FLAG (VERTICAL) OR HORIZONTAL POSITION. ALSO AVAILABLE IN OTHER LENGTHS OR WITH A MAGNET.

<u>PART #</u>	<u>CTN QTY</u>	<u>DESCRIPTION</u>	<u>WT PER/M</u>
108520	500	3" OAL STANDARD GRIP UP TO .100"	23.6 L bs
108551	500	3" OAL HEAVY DUTY GRIP .125"-.187"	29.5 L bs
108539	100	36" OAL STANDARD GRIP UP TO .100"	283.2 L bs
108552	100	36" OAL HEAVY DUTY GRIP .125"-.187"	354.0 L bs

HEAVY DUTY GRIPPER SIGN HOLDER-NARROW

1-1/2", 3" AND 6" LONG X 1/2" HEIGHT WITH 1/2" NARROW BASE WIDTH. HOLDS THICKER SIGNS HAVING 1/8" TO 3/16" THICKNESS. CLEAR PVC MATERIAL WITH ADHESIVE BACKING. ALSO AVAILABLE IN CUSTOM LENGTHS AND WITHOUT ADHESIVE.

PACKAGING: BULK.

NOTES: HEAVY DUTY STYLE HOLDS THICKER SIGN AND DISPLAY MATERIAL THAN STANDARD GRIPPER SIGN HOLDERS. GRIPPER FINS HOLD SECURELY IN EITHER FLAG (VERTICAL) OR HORIZONTAL POSITION. ADHESIVE BASE ADHERES TO CLEAN, FLAT SURFACES.

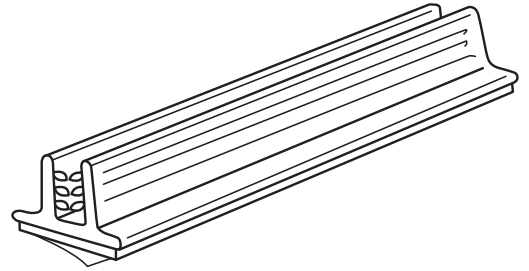

<u>PART #</u>	<u>CTN QTY</u>	<u>DESCRIPTION</u>	<u>WT PER/M</u>
108531	2,500	1-1/2" OVERALL LENGTH	7.1 Lbs
108532	1,000	3" OVERALL LENGTH	14.3 Lbs
108533	500	6" OVERALL LENGTH	28.5 Lbs

HEAVY DUTY GRIPPER SIGN HOLDER-WIDE

3" AND 6" LONG X 7/8" HEIGHT WITH 1" WIDE BASE WIDTH. HOLDS THICKER SIGNS HAVING 1/8" TO 1/4" THICKNESS. CLEAR PVC MATERIAL WITH ADHESIVE BACKING. ALSO AVAILABLE IN CUSTOM LENGTHS AND WITHOUT ADHESIVE.

PACKAGING: BULK.

NOTES: HEAVY DUTY STYLE HOLDS THICKER SIGN AND DISPLAY MATERIAL THAN STANDARD GRIPPER SIGN HOLDERS. WIDER BASE OFFERS MORE STABILITY. GRIPPER FINS HOLD SECURELY IN EITHER FLAG (VERTICAL) OR HORIZONTAL POSITION. ADHESIVE BASE ADHERES TO CLEAN, FLAT SURFACES.

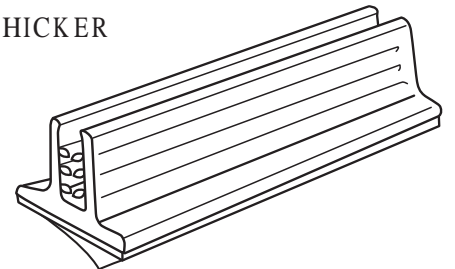

<u>PART #</u>	<u>CTN QTY</u>	<u>DESCRIPTION</u>	<u>WT PER/M</u>
108527	500	3" OVERALL LENGTH	22.5 Lbs
108528	250	6" OVERALL LENGTH	45.0 Lbs

GRIPPER SIGN HOLDER-EXTRA WIDE BASE

3" AND 6" LONG X 1-1/4" HEIGHT WITH 1-1/2" EXTRA WIDE BASE WITH ADHESIVE. HOLDS THICKER SIGNS HAVING 3/16" TO 1/4" THICKNESS. CLEAR PVC MATERIAL. ALSO AVAILABLE IN CUSTOM LENGTHS.

PACKAGING: BULK.

NOTES: GRIPPER FINS COUPLED WITH WIDE BASE OFFERS GREAT STABILITY AND STRENGTH. GRIPPER FINS HOLD LARGER SIGNS SECURELY IN EITHER FLAG (VERTICAL) OR HORIZONTAL POSITION. ADHESIVE BASE ADHERES TO CLEAN, FLAT SURFACES.

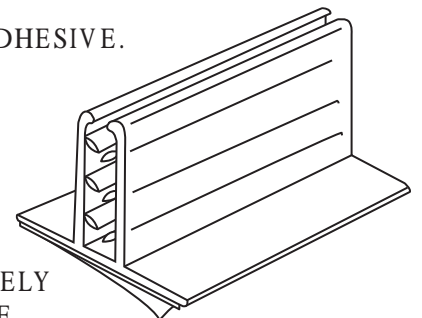

<u>PART #</u>	<u>CTN QTY</u>	<u>DESCRIPTION</u>	<u>WT PER/M</u>
108547	1,000	3" OVERALL LENGTH	49.6 Lbs
108548	500	6" OVERALL LENGTH	99.2 Lbs

GRIPPER T-STYLE TABLE TOP SIGN HOLDER

3" AND 6" LONG X 1-3/8" HEIGHT WITH 4" EXTRA-WIDE BASE (NO ADHESIVE). HOLDS THICKER SIGNS HAVING 3/16" TO 1/4" THICKNESS. CLEAR PVC MATERIAL. ALSO AVAILABLE IN CUSTOM LENGTHS AND WITH ADHESIVE.

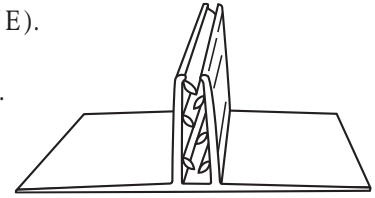

PACKAGING: BULK.

NOTES: GRIPPER FINS COUPLED WITH EXTRA WIDE 4 INCH BASE OFFERS GREAT STABILITY FOR TABLE TOP SIGNAGE.

<u>PART #</u>	<u>CTN QTY</u>	<u>DESCRIPTION</u>	<u>WT PER/M</u>
108553	500	3" OVERALL LENGTH	82 L bs
108554	250	6" OVERALL LENGTH	164 L bs

GONDOLA TOP GRIPPER SIGN HOLDER

3" AND 6" LONG X 1" HEIGHT X 2-3/4" WIDE BASE WITH GRIPPER FINS THAT ATTACH SECURELY ONTO THE TOP OF STANDARD RETAIL GONDOLAS. HOLDS SIGNS FROM 3/16"-1/4" THICK. CUSTOM LENGTHS AVAILABLE. CLEAR PVC MATERIAL.

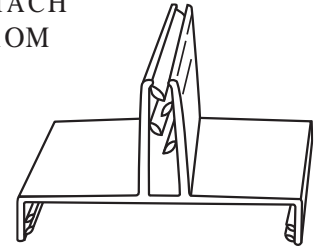

PACKAGING: BULK.

NOTES: GREAT FOR MOUNTING SIGNS ON TOP OF GONDOLAS WITHOUT THE NEED FOR ADHESIVE. REMOVABLE AND EASY TO RELOCATE. SOFT GRIPPER FINS ALLOW FOR EASY SIGN INSERTION AND HOLDS SIGNS FIRMLY IN PLACE.

<u>PART #</u>	<u>CTN QTY</u>	<u>DESCRIPTION</u>	<u>WT PER/M</u>
108555	500	3" OVERALL LENGTH	49.1 L bs
108556	250	6" OVERALL LENGTH	98.2 L bs

GRIPPER SQUARE EDGE SIGN HOLDER

3" LONG X 1-5/8" OVERALL HEIGHT WITH 1" BASE WIDTH TO FIT 7/8"-1" THICK SQUARE FIXTURE EDGES. 7/8" TALL GRIPPER FIN SECTION HOLDS SIGNS UP TO .125" THICK. ALSO AVAILABLE IN CUSTOM LENGTHS. CLEAR PVC MATERIAL.

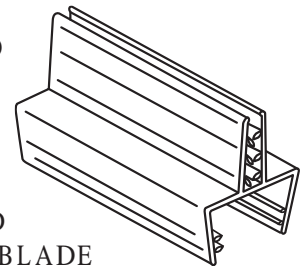

PACKAGING: BULK.

NOTES: ADD SIGNAGE VERTICALLY OR HORIZONTALLY TO METAL OR WOOD SQUARE EDGED FIXTURES. USE TWO PIECES TO HOLD LARGER GRAPHICS OR BLADE SIGNS. GRIPPER FINS HOLD SIGNS SECURELY.

<u>PART #</u>	<u>CTN QTY</u>	<u>DESCRIPTION</u>	<u>WT PER/M</u>
108564	500	3" OVERALL LENGTH	39.5 L bs

GRIPPER "U" CHANNEL PANEL FORMER

TWO SIZES AVAILABLE IN 48" LENGTHS. THE STANDARD SIZE HAS A BASE WIDTH OF 3/8" AND A HEIGHT OF 9/16" AND IS FOR 1/8"-3/16" THICK SIGNS. THE HEAVY DUTY SIZE HAS A BASE WIDTH OF 13/32" AND A HEIGHT OF 9/16" AND IS FOR 3/16"-1/4" THICK SIGNS. CLEAR OR WHITE PVC MATERIAL. CUSTOM LENGTHS AND COLORS AVAILABLE.

PACKAGING: BULK.

NOTES: MOUNT ON SIGN EDGES FOR A CLEAN, FINISHED LOOK. GRIPPER FINS HOLD SIGN AND DISPLAY MATERIALS STRAIGHT AND SECURE. ENGINEERED FOR A WIDE RANGE OF APPLICATIONS.

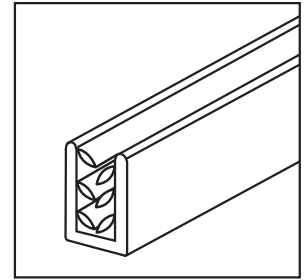

<u>PART #</u>	<u>CTN QTY</u>	<u>DESCRIPTION</u>	<u>WT PER/M</u>
108537	250	1/8"-3/16" GRIP X 48" LONG-CLEAR	163 L bs
108537W	250	1/8"-3/16" GRIP X 48" LONG-WHITE	163 L bs
108538	250	3/16"-1/4" GRIP X 48" LONG-CLEAR	175 L bs
108538W	250	3/16"-1/4" GRIP X 48" LONG-WHITE	175 L bs

GRIPPER 180 DEGREE "H" PANEL FORMER

TWO SIZES AVAILABLE IN 48" LENGTHS WITH BOTH HAVING 1" OVERALL HEIGHT. EACH SIDE OF THE STANDARD SIZE FITS 1/8"-3/16" THICK SIGN PANELS AND THE HEAVY DUTY SIZE FITS 3/16"-1/4" THICK SIGN PANELS. CLEAR OR WHITE PVC MATERIAL. CUSTOM LENGTHS AND COLORS ALSO AVAILABLE.

PACKAGING: BULK.

NOTES: GRIPPER FINS HOLD AND JOIN TWO SIGN PANEL EDGES SECURELY AT A FIXED 180 DEGREES. CAN BE USED IN BOTH VERTICAL OR HORIZONTAL POSITIONS FOR A CLEAN, FLAT FINISH.

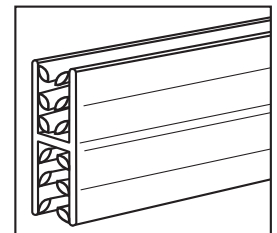

<u>PART #</u>	<u>CTN QTY</u>	<u>DESCRIPTION</u>	<u>WT PER/M</u>
108557	100	1/8"-3/16" GRIP X 48" LONG-CLEAR	298 L bs
108557W	100	1/8"-3/16" GRIP X 48" LONG-WHITE	298 L bs
108558	100	3/16"-1/4" GRIP X 48" LONG-CLEAR	304 L bs
108558W	100	3/16"-1/4" GRIP X 48" LONG-WHITE	304 L bs

GRIPPER 90 DEGREE TWO-WAY PANEL FORMER

1" LONG X 3/4" HEIGHT RIGHT ANGLES THAT HOLD UP TO .125 THICK SIGN PANELS. CLEAR PVC MATERIAL. CUSTOM LENGTHS AND COLORS ALSO AVAILABLE.

PACKAGING: BULK.

NOTES: GRIPPER FINS HOLD AND JOIN TWO SIGN PANEL EDGES SECURELY AT A FIXED 90 DEGREE ANGLE. USE SEVERAL PIECES TO BUILD AND CREATE UNIQUE DISPLAYS OR SIGNS HAVING RIGHT ANGLES.

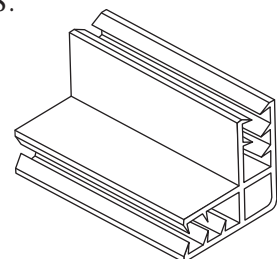

<u>PART #</u>	<u>CTN QTY</u>	<u>DESCRIPTION</u>	<u>WT PER/M</u>
108571	2,500	1" OVERALL LENGTH	8.1 L bs